

REF DU DOCUMENT : N0592 SUZ20072016 BAL

IFAB112

M.A.J Le :

Indice de modif :

Nom dessinateur :



SUZUKI BALENO SHVS

MODELE 2016

KIT SOCIETE













NOTICE DE MONTAGE



COMPOSITION DU COLIS

REF	DESIGNATION	QTE
N0592	NOTICE DE MONTAGE	1
TO0585	ENVELOPPE ARRET DE CHARGE	1
f0586	BRIDE DE SERRAGE	2
F0587	LONGERON SUPPORT PLANCHER	2
TO0588	TRAVERSE ARRIERE SUPPORT	1
TO0590	EQUERRE LATERALE SUPPORT PLANCHER	2
B0589	PLANCHER	1
M0594	MOQUETTE PLANCHER	1
V0593	SACHET VISSERIE VOIR COMPOSITION CI-DESSOUS	1

Composition du sachet de visserie :

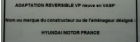
REF	DESIGNATION	QTE	PHOTOS
REF POM825	ANNEAU ARRIMAGE	4	
REF PLOTE6	ECROU M6 TENSILOCK	8	
REF PLOTE8	ECROU M8 TENSILOCK	4	
REF PLO616N	VIS POELIER 6x16 N	6	
REF PLOVP6X25	VIS POELIER 6x25 Z	4	
REF FOR925	VIS BOIS FIXATION PLANCHER	6	
REF PLOVH6X16	BOULON M6X16 TETE H	6	
REF PLOVH8X20	BOULON M8X20 TETE H	4	
REF PLT6	RONDELLE Ø24/6 EP 1.2	4	
REF PLT6	RONDELLE Ø14/6 EP 1.2	6	
REF MOS229	COLLIER RILSAN	6	
REF 400802	SACHET PLASTIQUE	4	
////	PLAQUE AUTOCOLLANTE DE TRANSFORMATION VASP	1	

KIT SOCIETE ARRET DE CHARGE

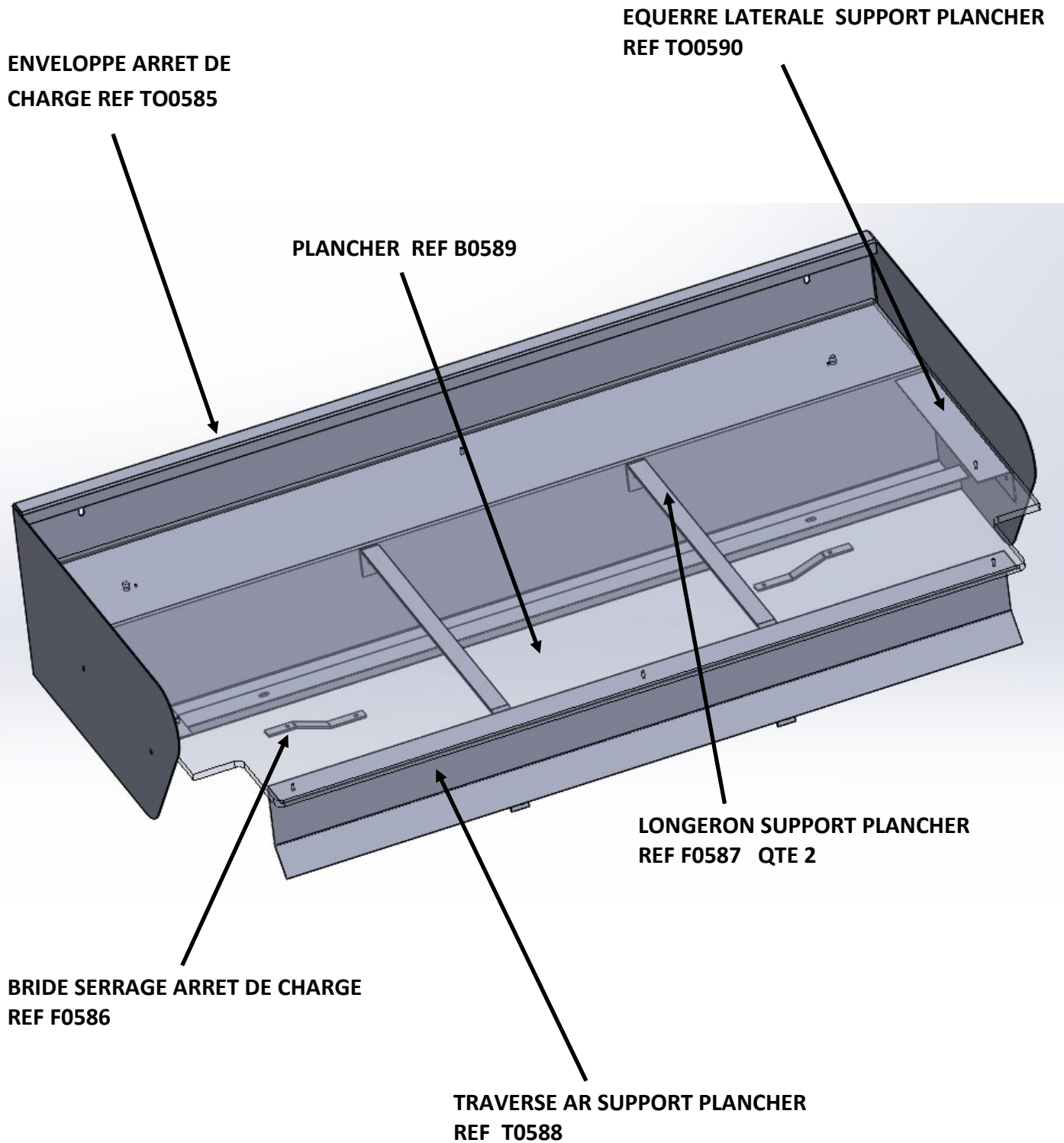

- 1) Réceptionner le véhicule et vérifier le N° de série .
Placer le véhicule sur une aire de travail propre et stable.
- 2) Contrôler le kit .
- 3) Lire la notice de montage.
- 4) Démontez les équipements dans l'ordre suivant :
 - a) Démontez les assises.
 - b) Démontez les dossiers.
 - c) Démontez les équipements du coffre.

Le véhicule doit être dans cette configuration pour fixer l'arrêt de charge.



d) Conditionner les ceintures.



REF 400802 X 2



REF MOS229 X 2

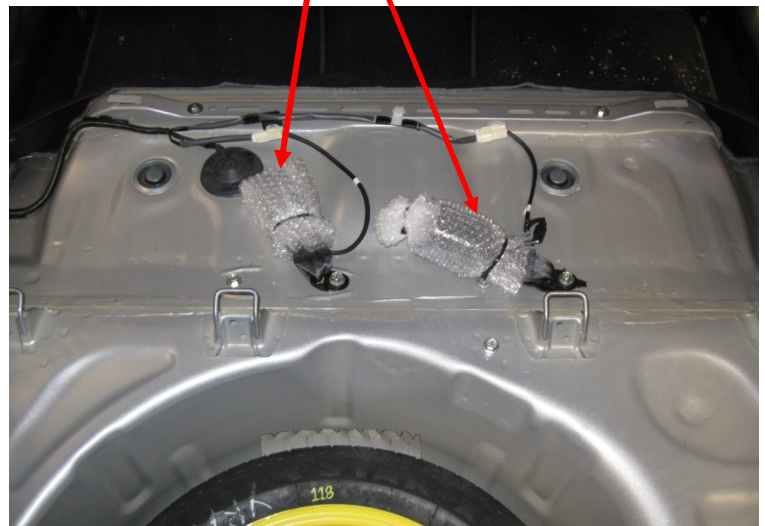

ATTENTION POUR LE CONDITIONNEMENT DES CEINTURES IL EST IMPERATIF DE LAISSER 50 cm DE GARDE POUR EVITER LE BLOPAGE DEFINITIF DU SYSTEME D'ENROULEUR .

e) Démontez les garnitures latérales .



f) Conditionner les enrouleurs .

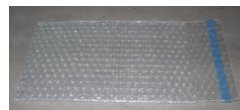
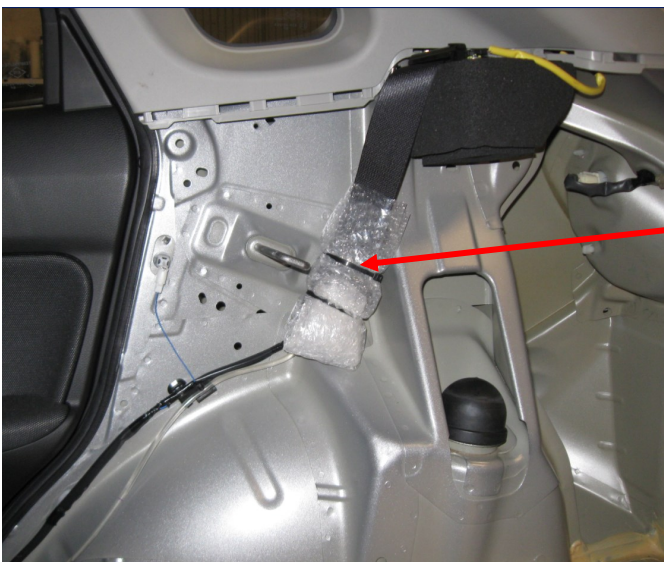

REF 400802 X 2



REF MOS229 X 4

5) Monter la structure métallique arrêt de charge dans l'ordre suivant :

a) Positionner et fixer les brides de serrage REF F0586 .

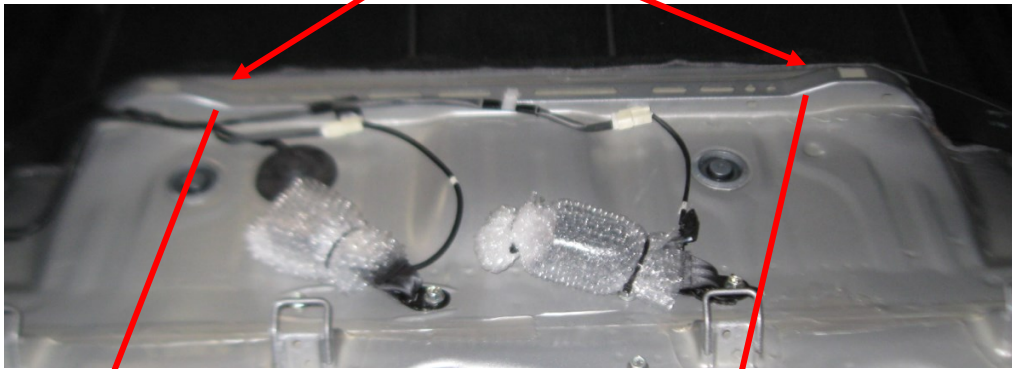

Montage idem G et D .



x 2 REF PLOVH6X16



x 2 REF PLT6



b) Positionner et fixer les équerres sur l'enveloppe arrêt de

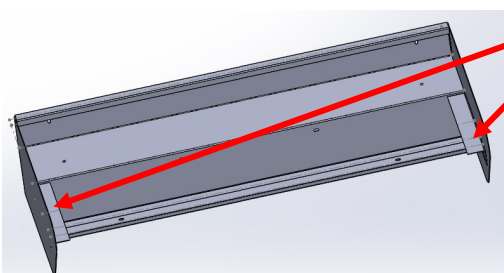

2 Equerres REF TO0590



REF PLOTE6 X 4

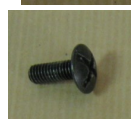

REF PLO616N X 4

c) Positionner et fixer l'enveloppe arrêt de charge REF



X 2 REF PLOVH6X16

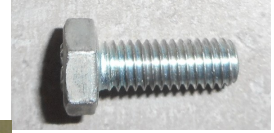

X 2 REF PLT6

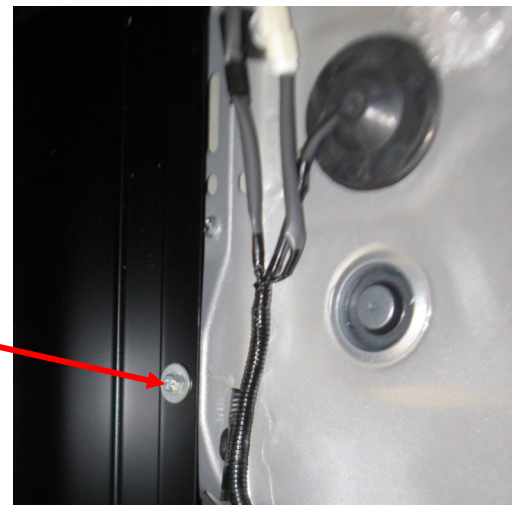

d) Positionner et fixer les longerons REF F0587.

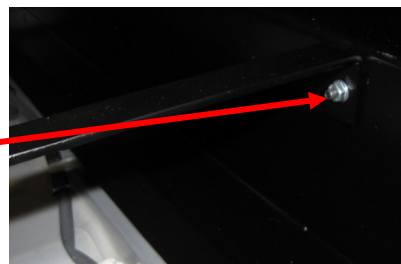
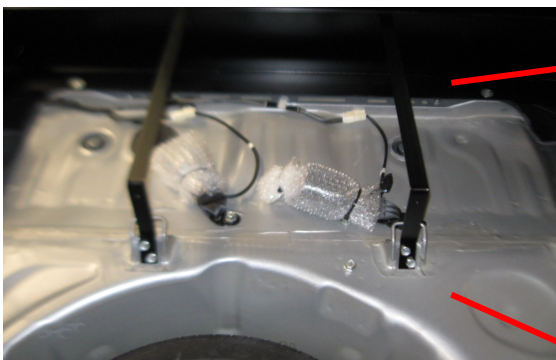

X 2



REF PLOTE6

X 2



REF PLO616N

X 4

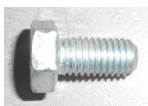

REF PLOVH8X20

X 4



REF PLOTE8

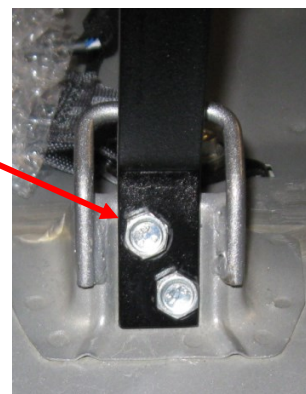

e) Positionner et fixer la traverse arrière REF F0588.

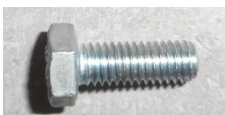
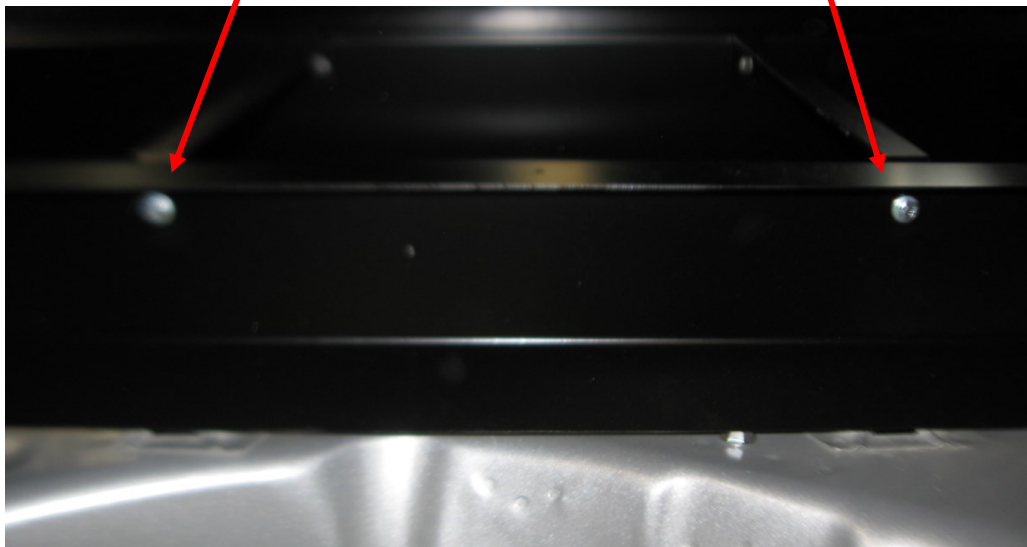
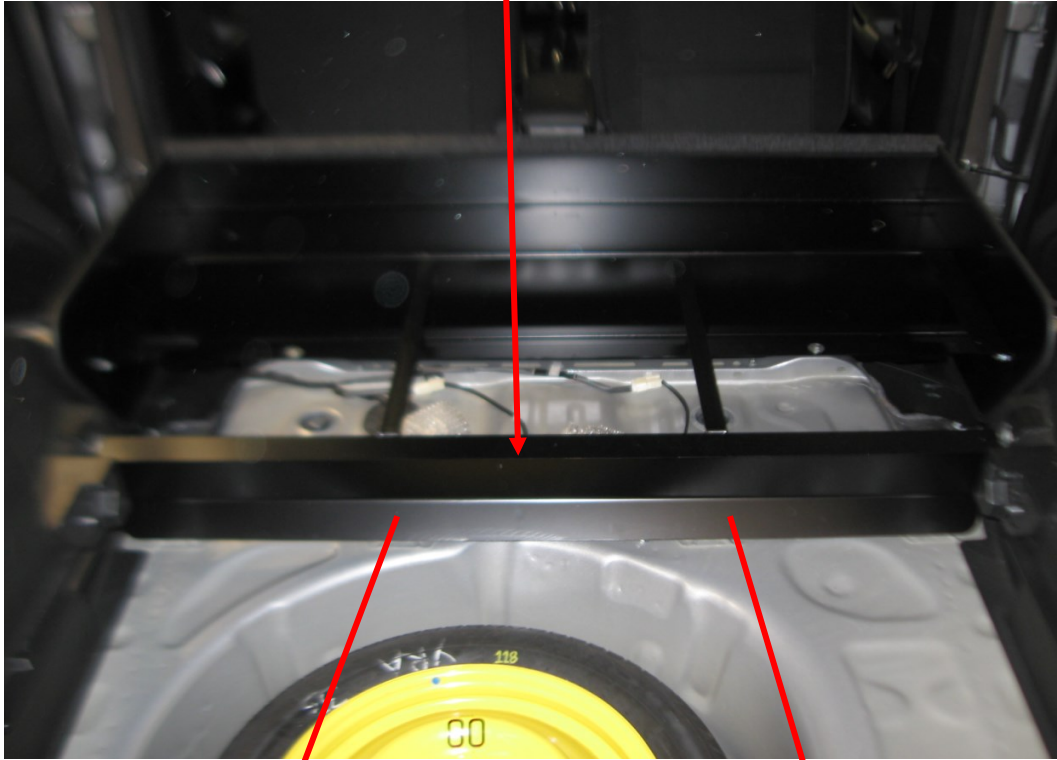

REF PLOVH6X16 X 2



REF PLT6 X 2

f) Remettre en place les équipements du coffre.

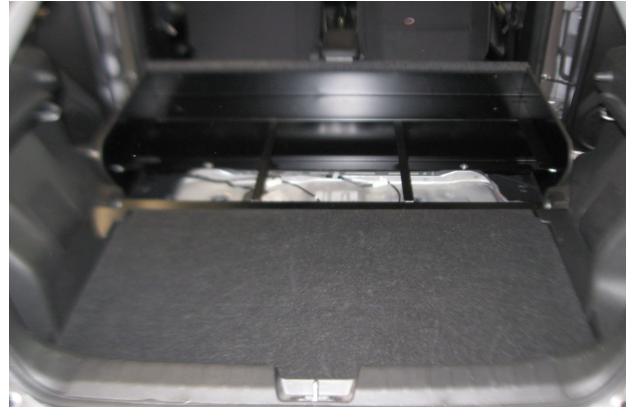

g) Positionner et fixer le plancher.

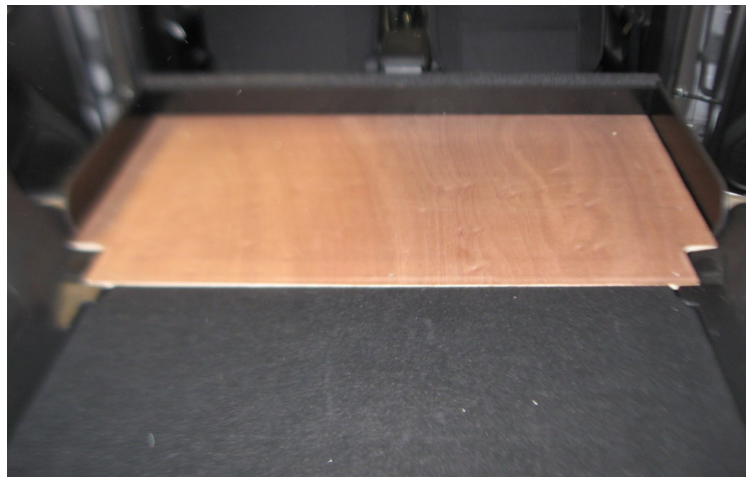

REF FOR925 X 6

h) Positionner la moquette.

h) Positionner et fixer les anneaux arrimage.



REF POM825 X 2



REF PLOVP6X25 X 2



REF PLT6 RONDELLE X 2



REF X 2



REF POM825 X 2



REF X 2



REF PLT6 RONDELLE X 2

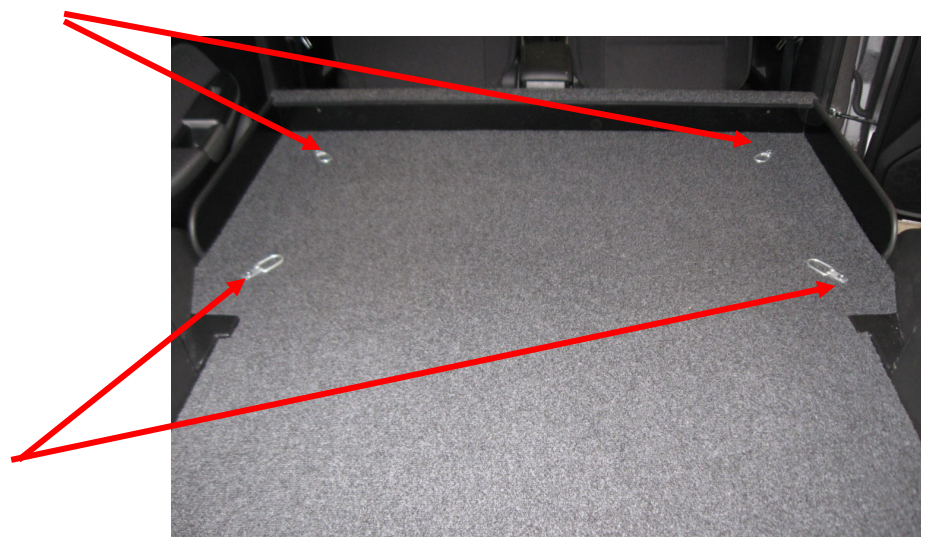

5) Coller la plaque de transformation :

Depuis l'entrée en vigueur de l'arrête du 7 Novembre 2014 , il n'y a plus ni plaque de tare ni plaque de chargement a apposer sur un véhicule transformé en VASP

LA PLAQUE AUTOCOLLANTE EST EXPEDIEE AVEC LE KIT .

(DANS LE SACHET DE VISSERIE)

COLLER LA PLAQUE DE TRANSFORMATION A PROXIMITE DE LA PLAQUE CONSTRUCTEUR.

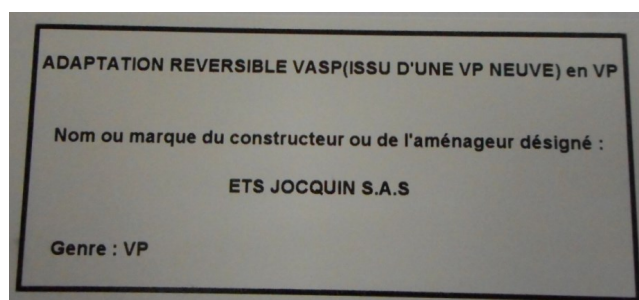

6) Nettoyer le véhicule.

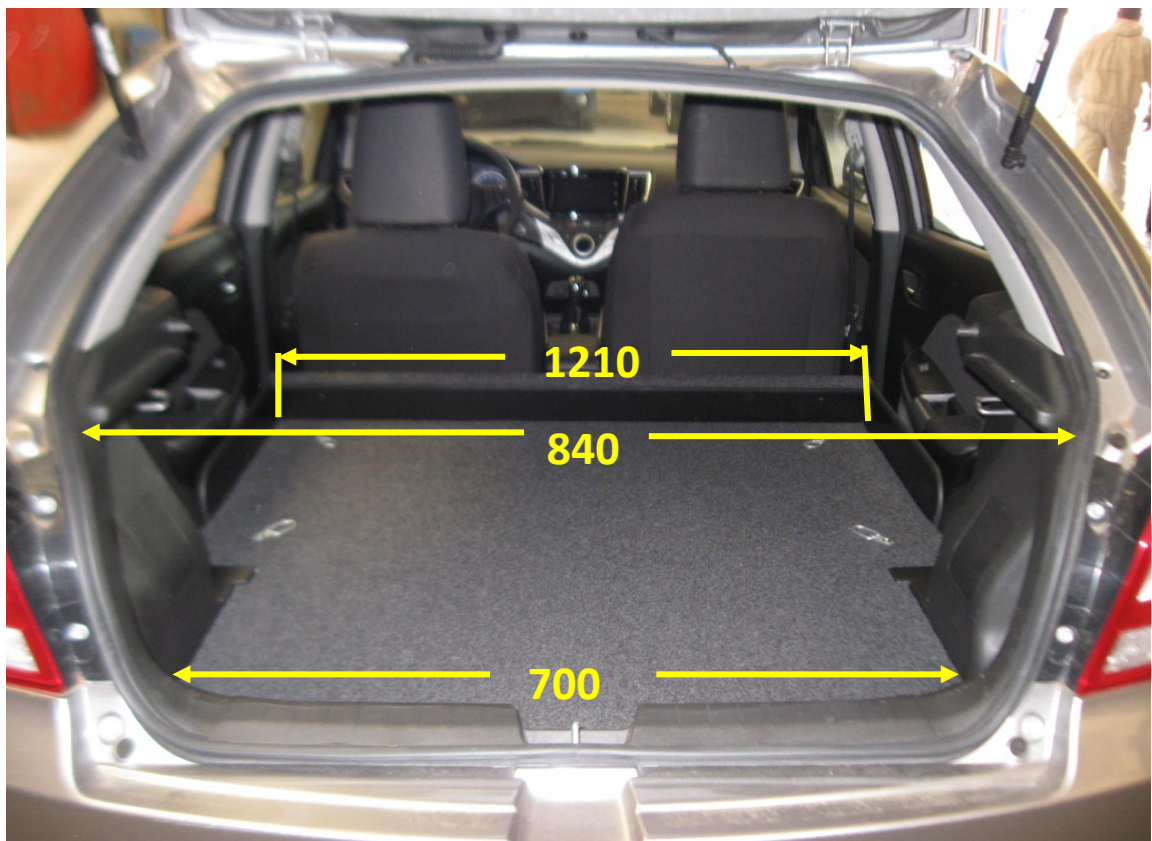
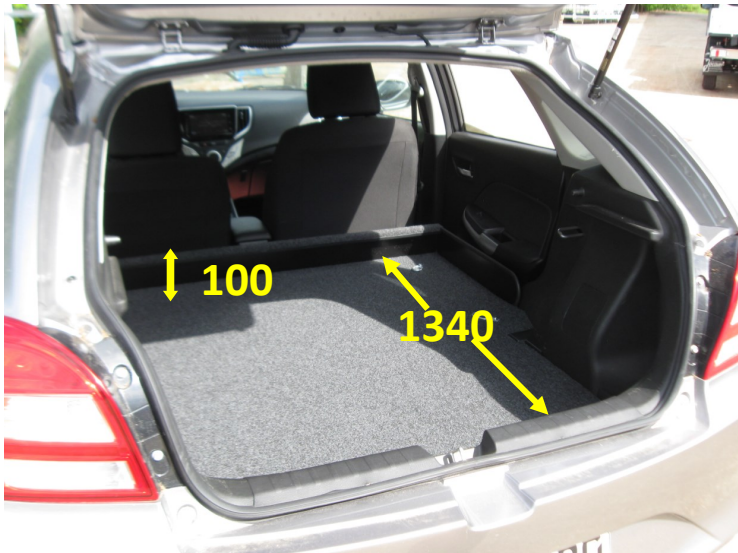
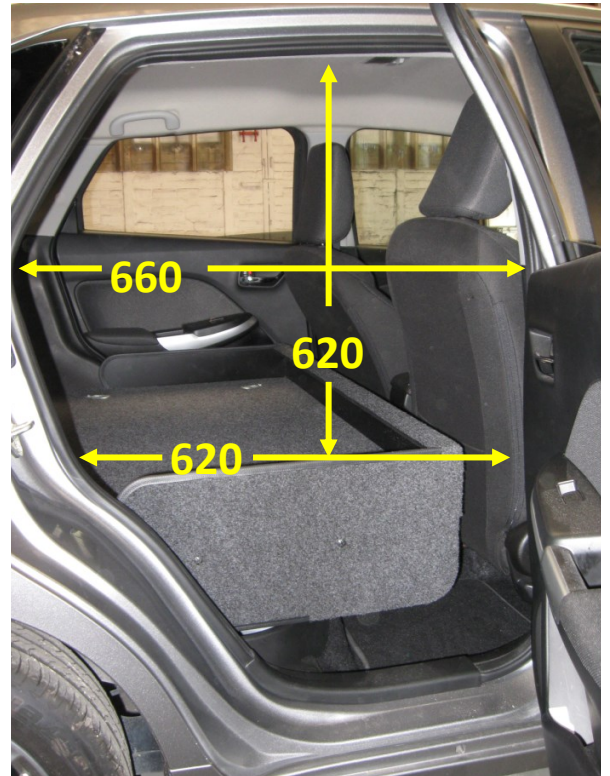
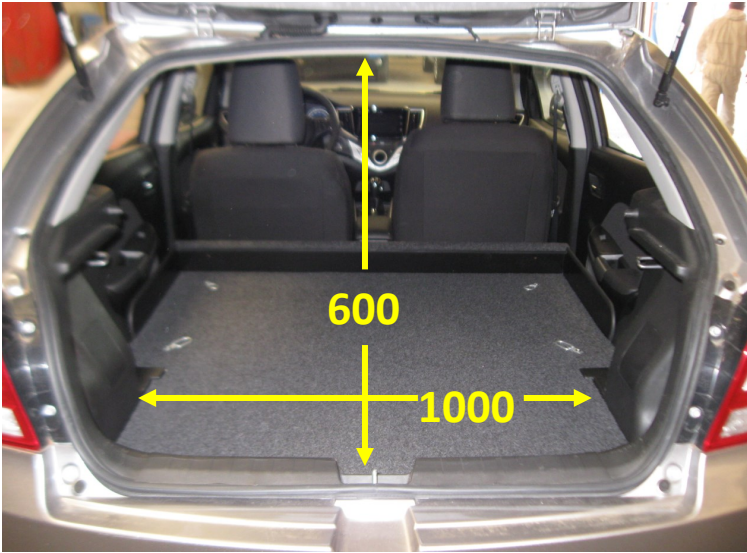



MARQUE DU VEHICULE :	
TYPE DU VEHICULE :	
N° de CLEF du VEHICULE :	

IFAB111

INDICE A

	OPERATION	Conforme	Non conforme	OBSERVATIONS
		C	NC	
1	RECEPTION DU VEHICULE VERIFIER N° SERIE	C	NC	
2	CONTRÔLE DU KIT	C	NC	
3	PRESENCE NOTICE MONTAGE	C	NC	
4	DEMONTAGE des EQUIPEMENTS SELON MODE OPERATEUR	C	NC	
5	PREPARATION DE L'HABITACLE Ex : vis pastilles joints	C	NC	
6	MONTAGE STRUCTURE METALLIQUE ARRET DE CHARGE	C	NC	
7	FIXATION DU PLANCHER SELON COUPLE DE SERRAGE	C	NC	
8	POSE DE LA MOQUETTE VERIFIER L'ETAT	C	NC	
9	INSTALLATION ELEMENTS FINITION Vérifier : caches, carres de moquette, anneau arrimage	C	NC	
10	POSE DE L'ETIQUETTE VASP	C	NC	
11	NETTOYAGE DU VEHICULE	C	NC	

NOM DU MONTEUR :	
DATE DE L'INTERVENTION :	
SIGNATURE DU MONTEUR :	

CACHET DU CARROSSIER / GARAGISTE :