







**HYUNDAI I30 5P - SW - I30N SPORT 2017**  
**COUVRE BAGAGES**

.



**COUVRE BAGAGES**

**COMPOSITION DU COLIS**

REF	DESIGNATION	QTE
N0790 HY	NOTICE DE MONTAGE	1
S0813 HY	ARCEAU COUVRE BAGAGES	2
CB0814 HY	COUVRE BAGAGES	1
F0811 HY	PLATINE SERRAGE COUVRE BAGAGES	2
		
V0794 HY	SACHET DE VISSERIE ( voir ci-dessous composition du sachet de visserie )	1
	<b>COMPOSITION DU SACHET DE VISSERIE</b>	
PLO616N	<b>POELIERS 6 x 16</b>	4
		
BOU6271	BOUTONS CEVENNES M6	4
		
PLOVJ5X40	VIS JAPY 5X40	2
		
BOU6211	BOUTONS CEVENNES M5	2
		

COUVRE BAGAGES

ARCEAUX COUVRE BAGAGES

( QTE : 2 )

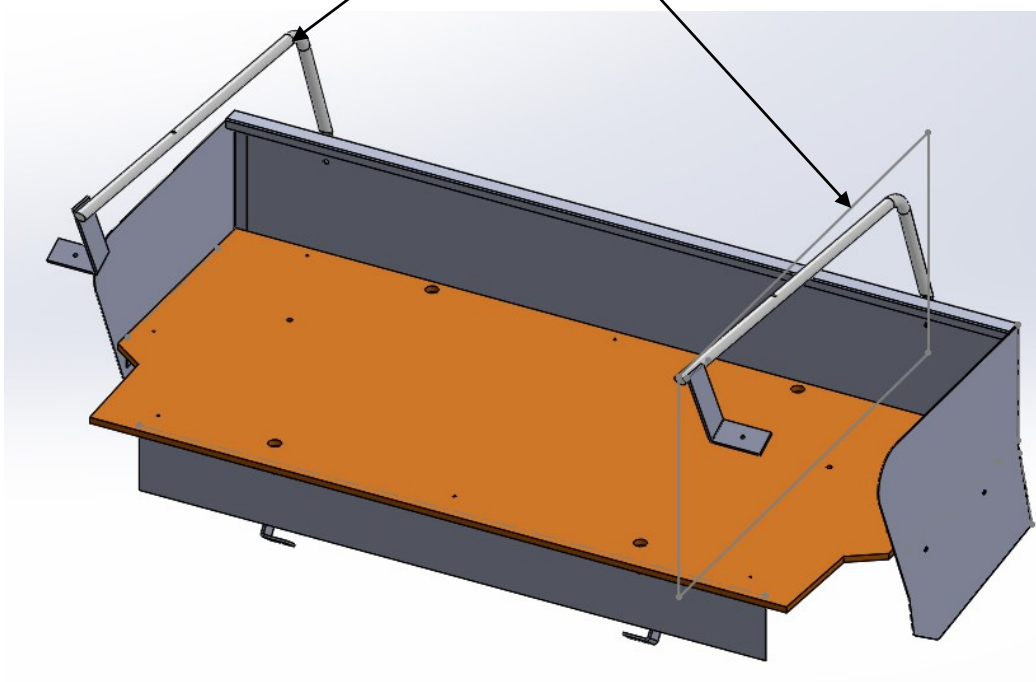

COUVRE BAGAGES

1) Réceptionner le véhicule et vérifier le N° de série .

Placer le véhicule sur une aire de travail propre et stable.

2) Contrôler le kit .

3) Lire la notice de montage.

4) Fixer les 2 arceaux .

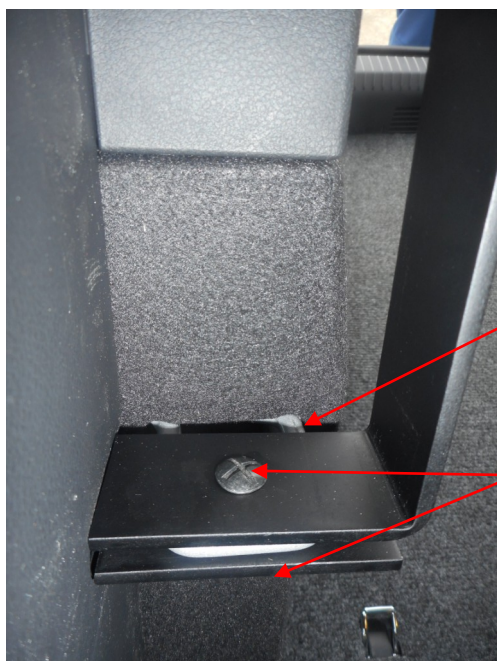

ANNEAU DE FIXATION  
BANQUETTE

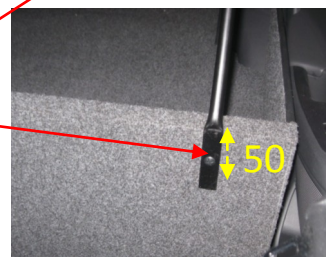
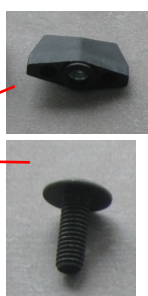



COUVRE BAGAGES

4 ) Positionner le couvre bagages .



5 ) contre-percer le couvre bagages et le fixer .



6 ) Nettoyer le véhicule .