

M.A.J Le : 25/01/2022
Indice de modif : Ind A
Nom dessinateur : JR



SUZUKI IGNIS ATK 2020 KIT SOCIETE NOTICE DE MONTAGE



COMPOSITION DU COLIS

















REF	DESIGNATION	QTE
S0960	ARRET DE CHARGE	1
TO0948	FLASQUE U	1 (Nota 1)
TO0946	RENFORT TRAVERSE MILIEU	1
TO0945	PETITE EQUERRE LATERALE	2
TO0944	GRANDE EQUERRE ARRIERE	1
TO0947	TRAVERSE LONGITUDINALE	2 (Nota 1)
B0952	PLANCHER AVANT	1
B0953	PLANCHER ARRIERE	1
B0954	CALE (VERSION 4X4)	2
B0956	CALE (VERSION 4X2)	2
B0955	TASSEAU RENFORT PLANCHER	1
M0964	MOQUETTE	1
V0963	SACHET DE VISSERIES	1
N0965	NOTICE DE MONTAGE	1

Nota1 : Uniquement pour version banquette mobile



Si version banquette fixe en remplacement des réf
TO0947 et TO0948

REF	DESIGNATION	QTE
TO3722	TRAVERSE ARRIERE	1
TO3723	TRAVERSE AVANT	1
F3724	PLATINE ECROU	2

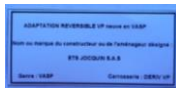
Composition du sachet de visserie

REF ARTICLE	DESIGNATION	QTE	PHOTO
PLOVP816 Z	VIS POELIER 8 X 16 Z	2	
PLOVP616 Z	VIS POELIER 6 X 16 Z	4	
PLOVP616 N	VIS POELIER 6 X 16 N	13	
PLOVH 820	VIS HEXAGONALE 8 X 20	4	
FOR 295	VIS CHARNIERE	8	
VIS BOIS 3,5 x 30	VIS A BOIS 3,5 x 30	11	
BER021756	VIS AUTOFORANTE 3,9 x 25	10	
RONDELLELOURDE10	RONDELLE LOURDE Ø10 INT 4	6	
PLOMU8	RONDELLE PLATE Ø 18	4	
PLOCL6	ECROU TENSILOCK M6	7	
FOR791	CLIPS ECROU	6	
NIOZET1234	BOUCHON EN PLASTIQUE	2	
CHARNIEREPLANCHER	CHARNIERE PLANCHER	2	
ANNEAU ARRIMAGE	ACIER GALVA	2	
FOR200	RILSAN	2	
SACHET	SACHET PLASTIQUE	2	
	Plaque autocollante de Transformation VASP	1	

+ Si version banquette fixe

REF ARTICLE	DESIGNATION	QTE	PHOTO
PLOVH 625	VIS HEXAGONALE M6 X 25	2	
PLOMU6	RONDELLE M6	2	
F3724	PLAQUE ECROU	2	

KIT SOCIETE ARRET DE CHARGES

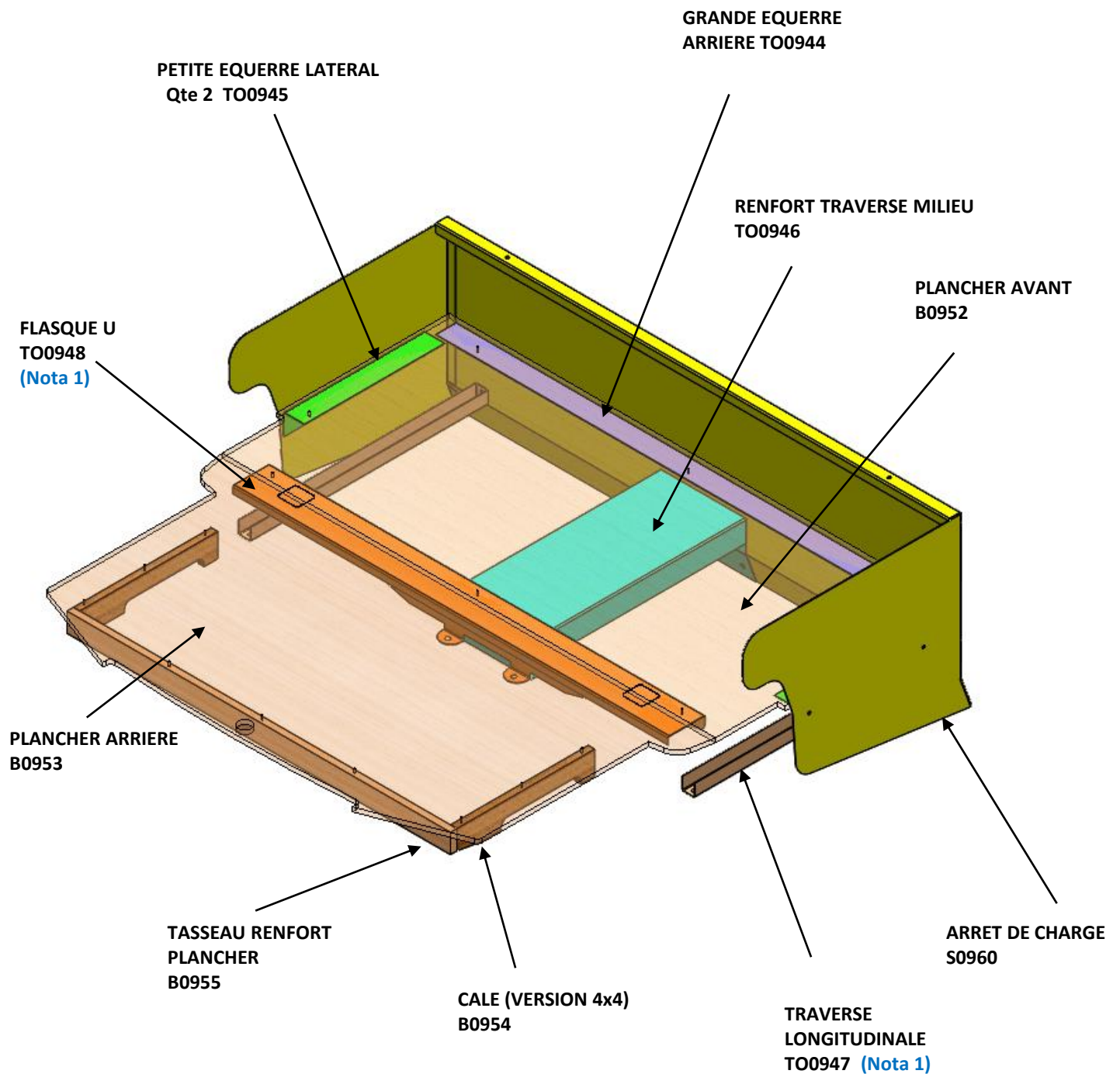

Nota1 : Uniquement pour version banquette mobile

KIT SOCIETE ARRET DE CHARGES

Si version banquette fixe en remplacement des réf
T00947 et T00948

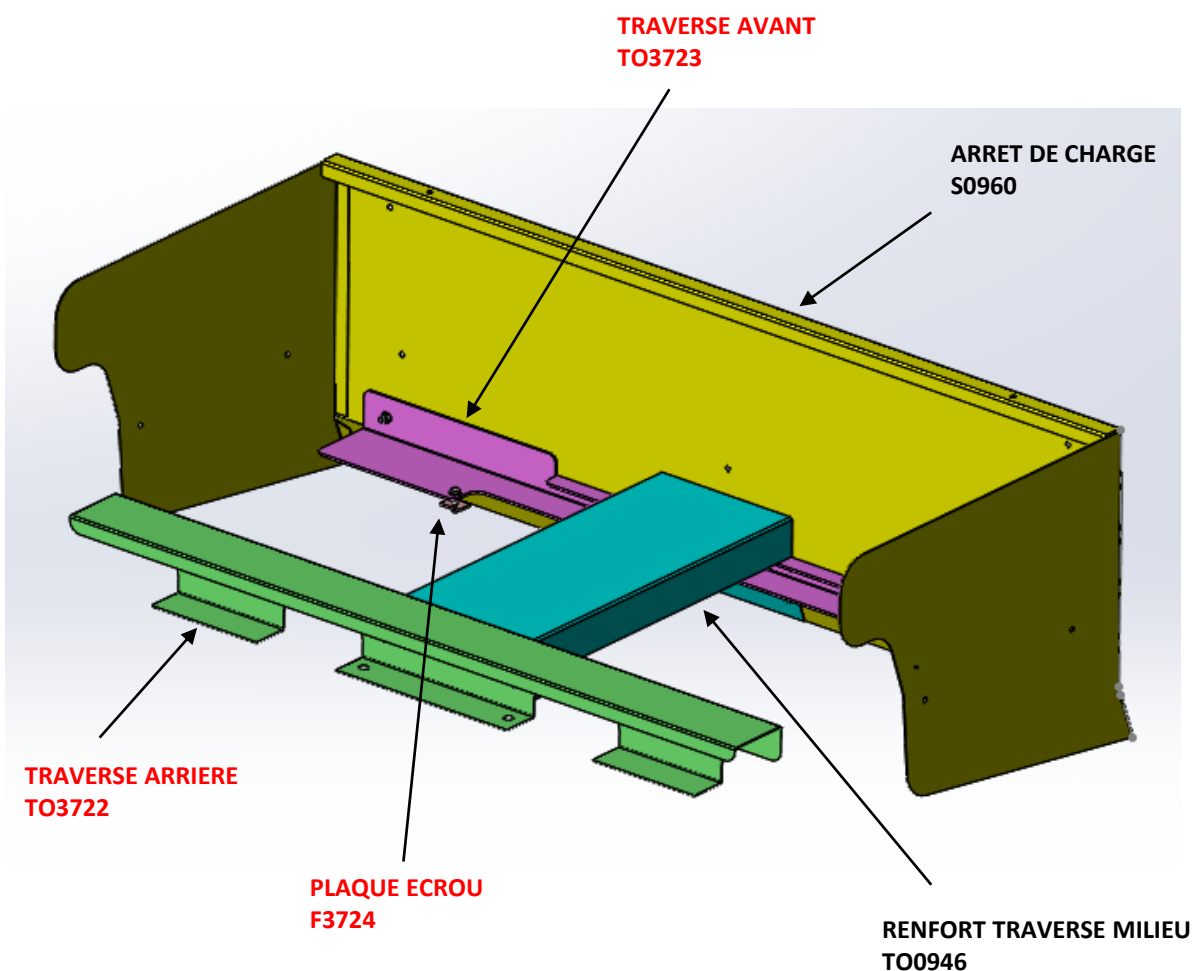

KIT SOCIETE ARRET DE CHARGES

- 1) Réceptionner le véhicule et vérifier le N° de série.
Placer le véhicule sur une aire de travail propre et stable
- 2) Contrôler le kit
- 3) Lire la notice de montage téléchargé sur le site jocquin.com

ATTENTION :

LA BATTERIE DU VEHICULE DOIT IMPERATIVEMENT ETRE DEBRANCHEE
PENDANT LA DUREE DE L'INTERVENTION

- 4) Démontez les équipements dans l'ordre suivant :

- a) Démontez la banquette arrière
et les dossiers



KIT SOCIETE ARRET DE CHARGES

b) Démonter les garnitures latérales et centrales



GARNITURE A DEMONTER



c) Conditionner les ceintures de sécurités



SACHET PLASTIQUE
QTE : 2

 Positionner les ceintures comme ceci pour pouvoir remettre les garnitures

DES 2 COTES



REF NIOZET1234
Qté : 2

Mettre les bouchons plastiques si votre kit ne possède pas de grille arrêt de charge

d) Repositionner les garnitures

ATTENTION :

DANS TOUS LES CAS, POUR LE CONDITIONNEMENT DES CEINTURES IL EST IMPERATIF DE LAISSER 50 cm DE GARDE POUR EVITER LE BLOCAGE DEFINITIF DU SYSTEME D'ENROULEUR.

**L' HABITACLE DOIT ETRE DANS CETTE CONFIGURATION
POUR MONTER L' ARRET DE CHARGES**

Version banquette mobile



Version banquette fixe



KIT SOCIETE ARRET DE CHARGES

5) Mise en place des équerres arrière et latérale TO0944 et TO0945 sur l'arrêt de charges S0960

Arrêt de charges
S0960

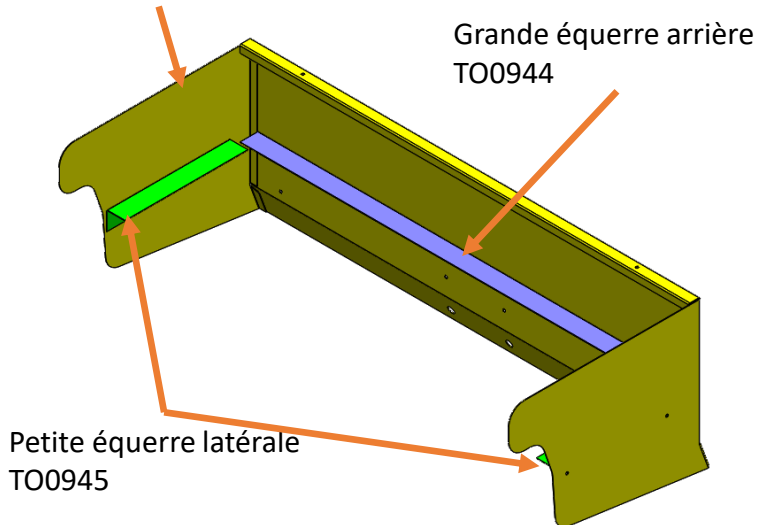

Ceci à l'aide de 7 Vis poêliers M6
et 7 écrous tansilock M6



REF PLOVP616 N
Qté : 7



REF FOR 0736
Qté : 7

6) Mise en place du renfort traverse milieu TO0946

Mettre en place 4 clips écrou sur le renfort

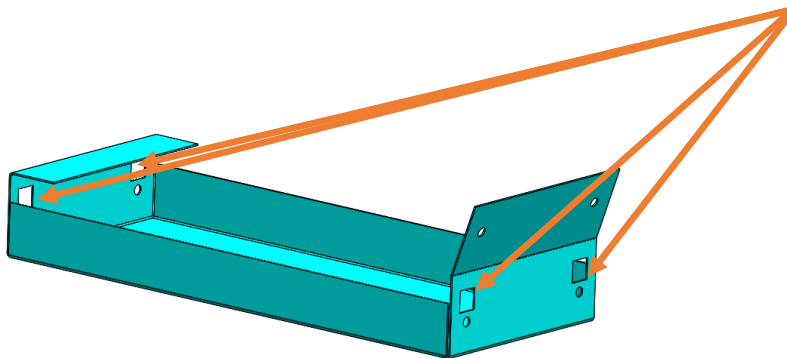

REF FOR 791
Qté : 4

KIT SOCIETE ARRET DE CHARGES

Pour la version banquette mobile

Positionner 2 rondelles lourdes sur les fixations d'origine du véhicule, puis venir fixer le renfort à l'aide de 2 vis poêlier M8 x 16

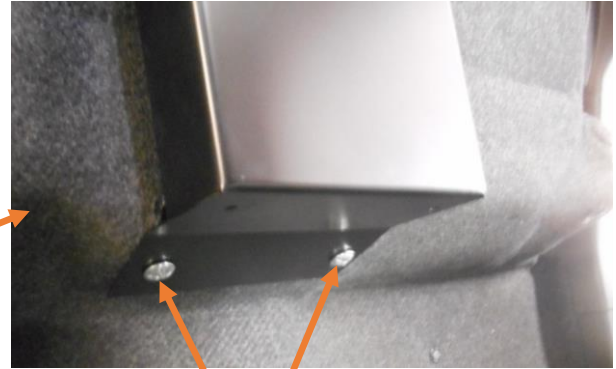
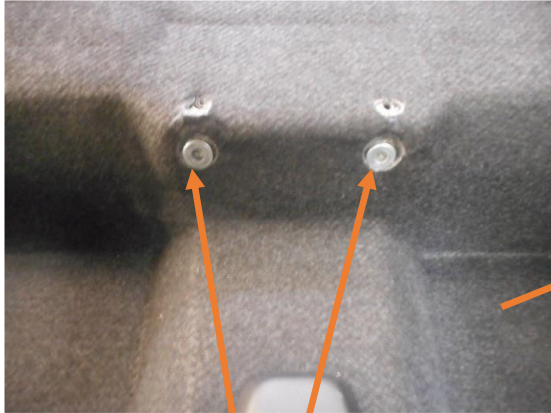

Rondelles lourdes Ø10
Qté : 2



REF PLOVP816
Qté : 2

7) Mettre en place le flasque U TO0948

Positionner 2 rondelles lourdes sur les fixations d'origine du véhicule et fixer le flasque U à l'aide de 2 vis hexagonale M8 x 20, 2 rondelles plate et 2 vis poêlier M6 x 16 qui iront se visser dans le renfort.



REF PLOVP616
Qté : 2

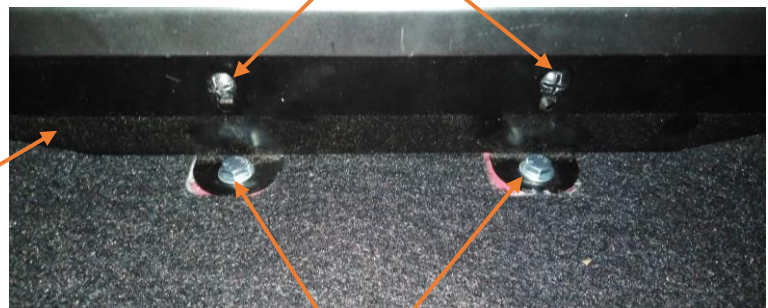

REF PLOVH 820
Qté : 2



REF PLOMU8
Qté : 2

KIT SOCIETE ARRET DE CHARGES

8) Fixer les traverses TO0947 sur le véhicule

Mettre 2 clips écrous sur les traverses

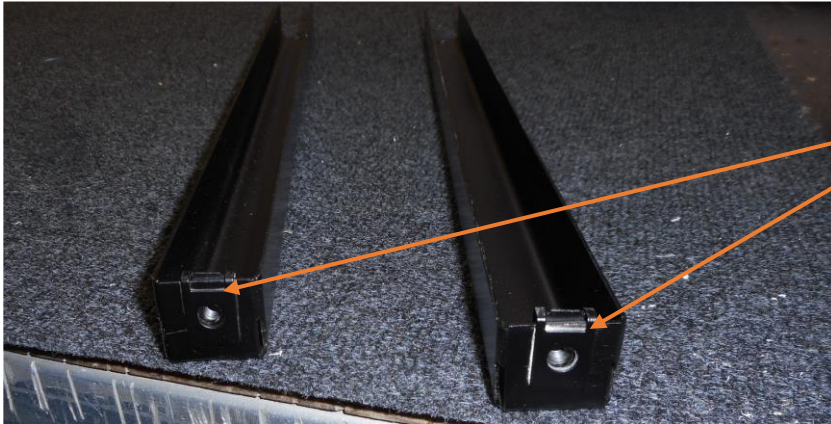

REF FOR 791
Qté : 2

Fixer les traverses sur le véhicule à l'aide de 2 rondelles lourdes, 2 vis hexagonale M8 x 20 et 2 rondelles M8



Rondelles lourdes Ø10
Qté : 2



REF PLOVH 820
Qté : 2



REF PLOT8
Qté : 2

KIT SOCIETE ARRET DE CHARGES

9) Mettre en place l'arrêt de charge S0960

Fixer l'arrêt de charge à l'aide de 4 vis poêlier M6 x 16

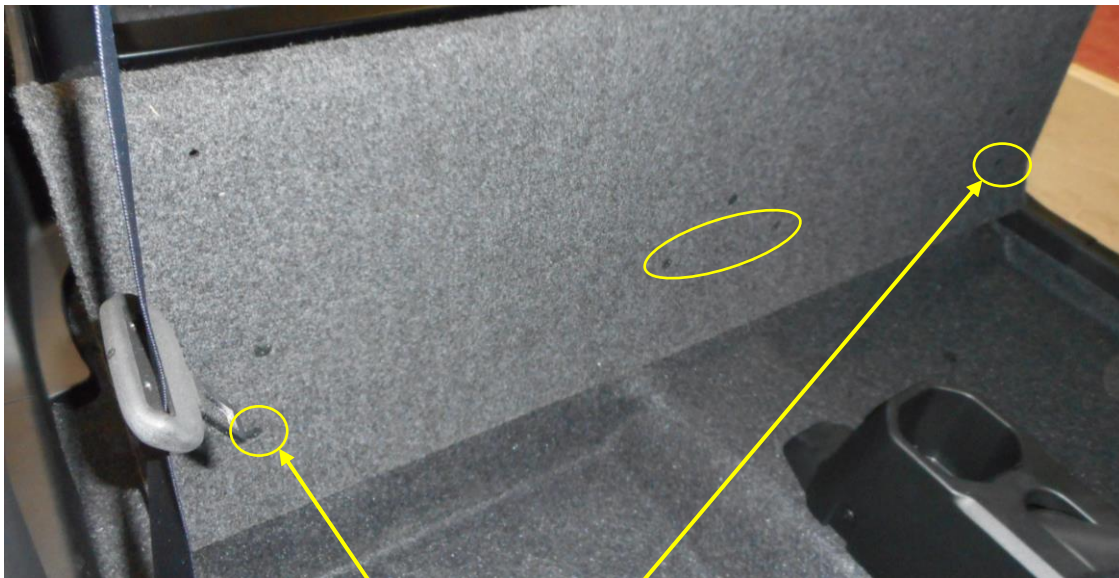

REF PLOVP616 N
Qté : 4

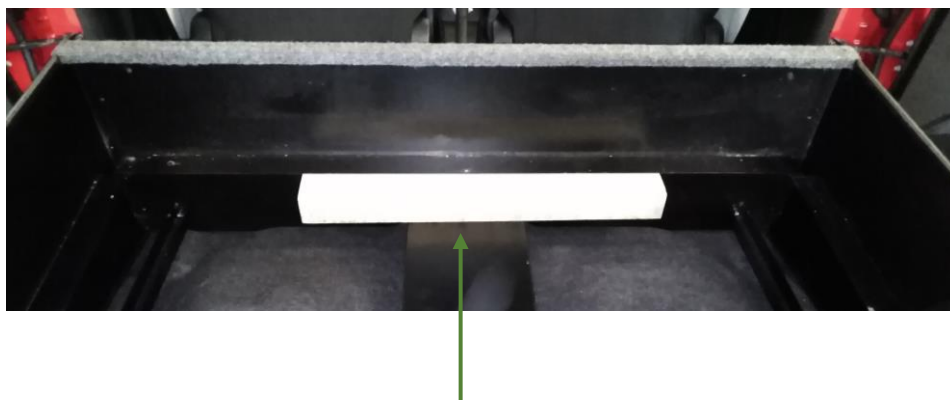

Astuce:

Pour faciliter le montage de l'arrêt de charge on peut utiliser une cale de 50 mm.

KIT SOCIETE ARRET DE CHARGES

Pour la version banquette fixe

10) Fixation de la traverse avant TO3723

Enlever les deux pièces plastique support assise banquette



Puis mettre les platines écrou réf F3724 sur la traverse avant TO3723 à l'aide de 2 vis hexagonales M6x25 et 2 rondelles Ø 6

Traverse avant TO3723

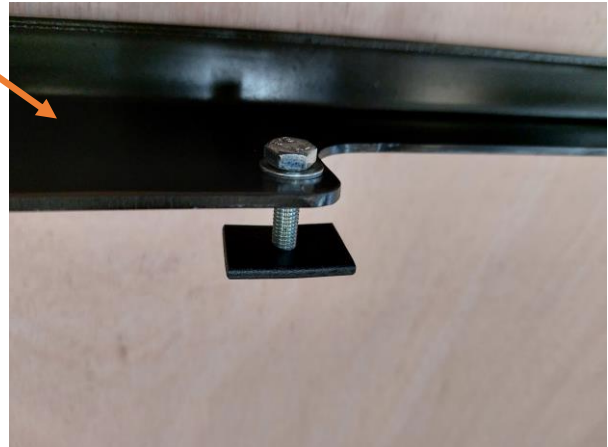

REF PLOVH625
Qté : 2



REF PLOMU6
Qté : 2



Platine écrou F3724
Qté : 2

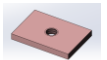

Puis venir positionner la traverse avant TO3723 et passer les platines écrou dans les orifices rectangles



Traverse avant TO3723

Profil du véhicule

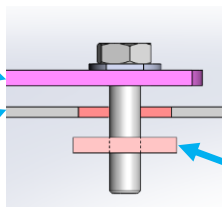

Platine écrou F3724



KIT SOCIETE ARRET DE CHARGES

11) Fixation de la traverse arrière TO3722

Positionner la traverse arrière TO3722 et la fixer sur les fixations d'origine du véhicule avec 2 vis hexagonale M8 x 20, 2 rondelles plate.

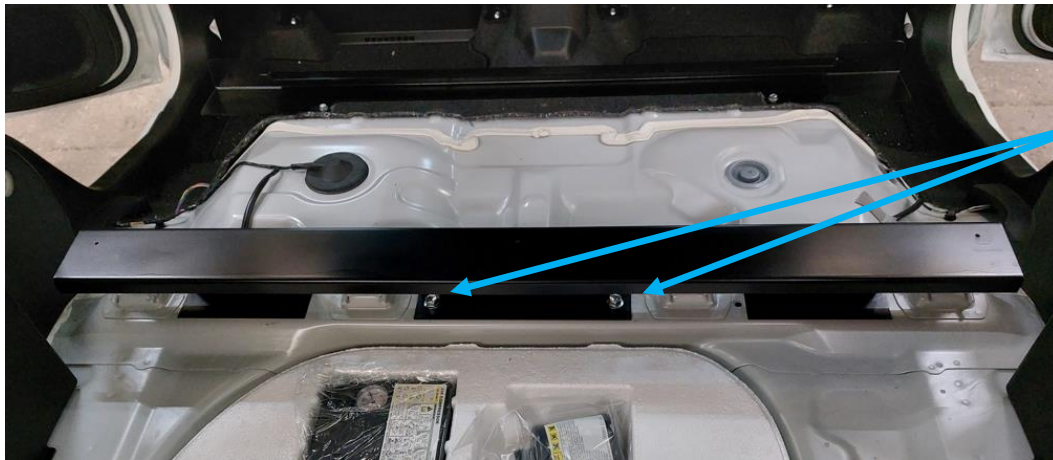

REF PLOVH 820
Qté : 2



REF PLOMU8
Qté : 2

12) Mise en place du renfort traverse milieu TO0946

Positionner le renfort traverse milieu et venir le fixer sur la traverse arrière TO3722 à l'aide de 2 vis poêlier M6x16.

Traverse arrière
TO3722

Renfort traverse
milieu TO0946

Traverse avant
TO3723

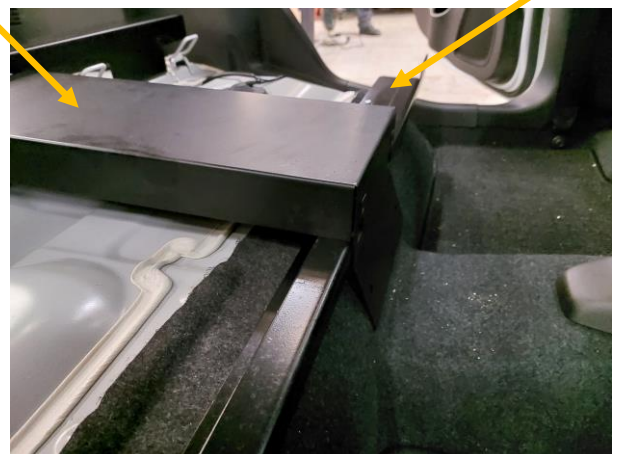
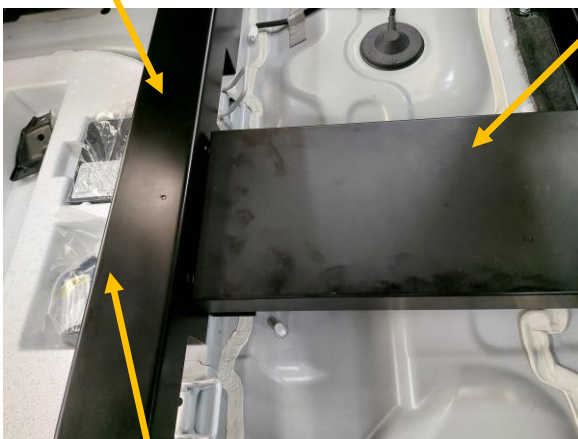

REF PLOVP 616 Z
Qté : 2



KIT SOCIETE ARRET DE CHARGES

13) Mettre en place l'arrêt de charge S0960

Astuce:
Pour faciliter le montage de l'arrêt de charge on peut utiliser une cale de 50mm.



Mettre en place l'arrêt de charge S0960 et venir le fixer à l'aide de 2 vis poêlier M6x16 sur le renfort traverse milieu TO0946

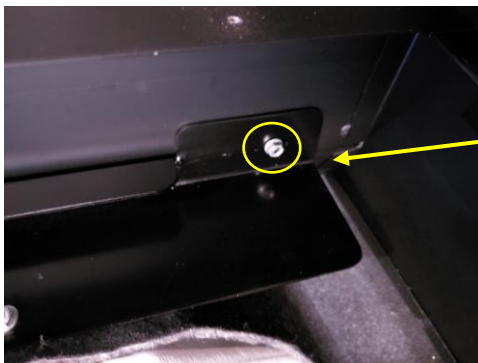

Et venir fixer l'arrêt de charge sur la traverse avant TO3723 à l'aide de 2 vis poêlier M6x16 et 2 écrous tensilock M6

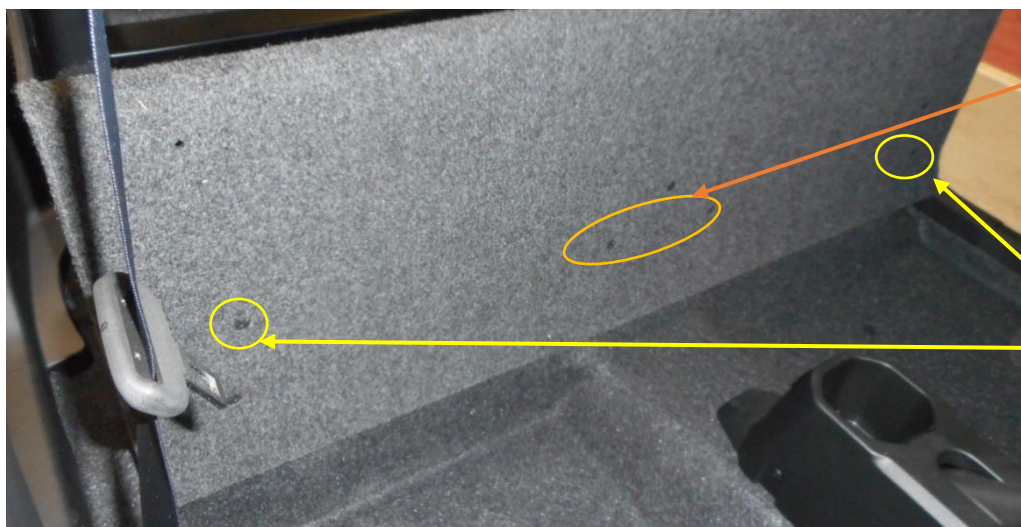

REF PLOVP616 N
Qté : 4



REF FOR 0736
Qté : 2

KIT SOCIETE ARRET DE CHARGES

14) Montage du plancher avant B0952

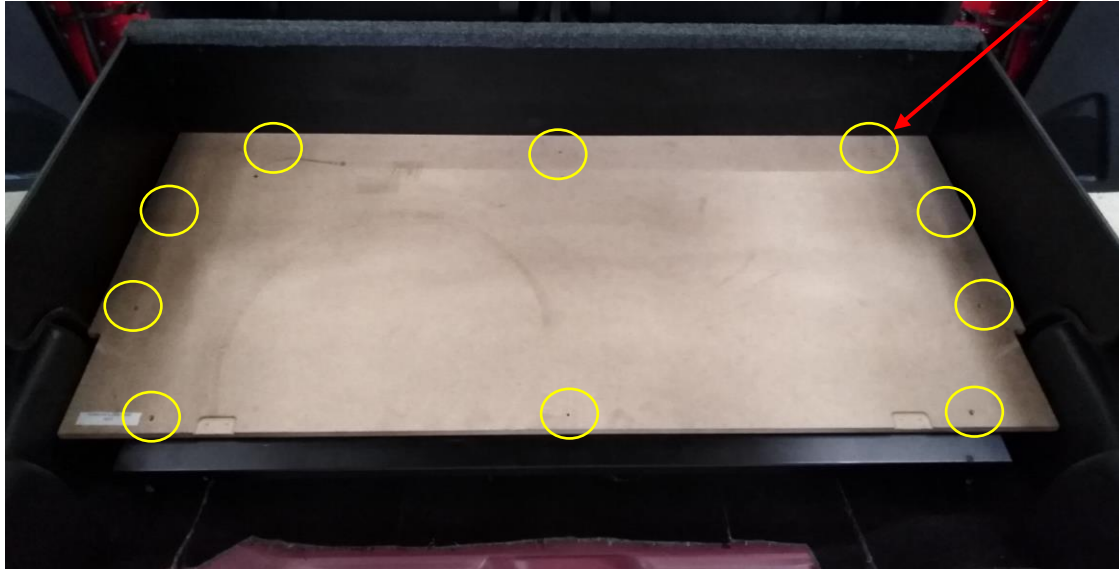

Vis autoforante
BER 021756
Qté : 10

15) Remettre les outils de réparation à leurs places initial



Outils de réparations

16) Fixer les cales sur le plancher arrière en fonction du véhicule

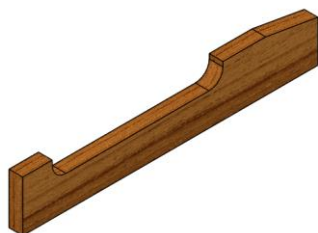

Cale (version 4x4)
B0954



Cale (version 4x2)
B0956

KIT SOCIETE ARRET DE CHARGES

Positionner les cales et les fixer à l'aide de 11 vis a bois

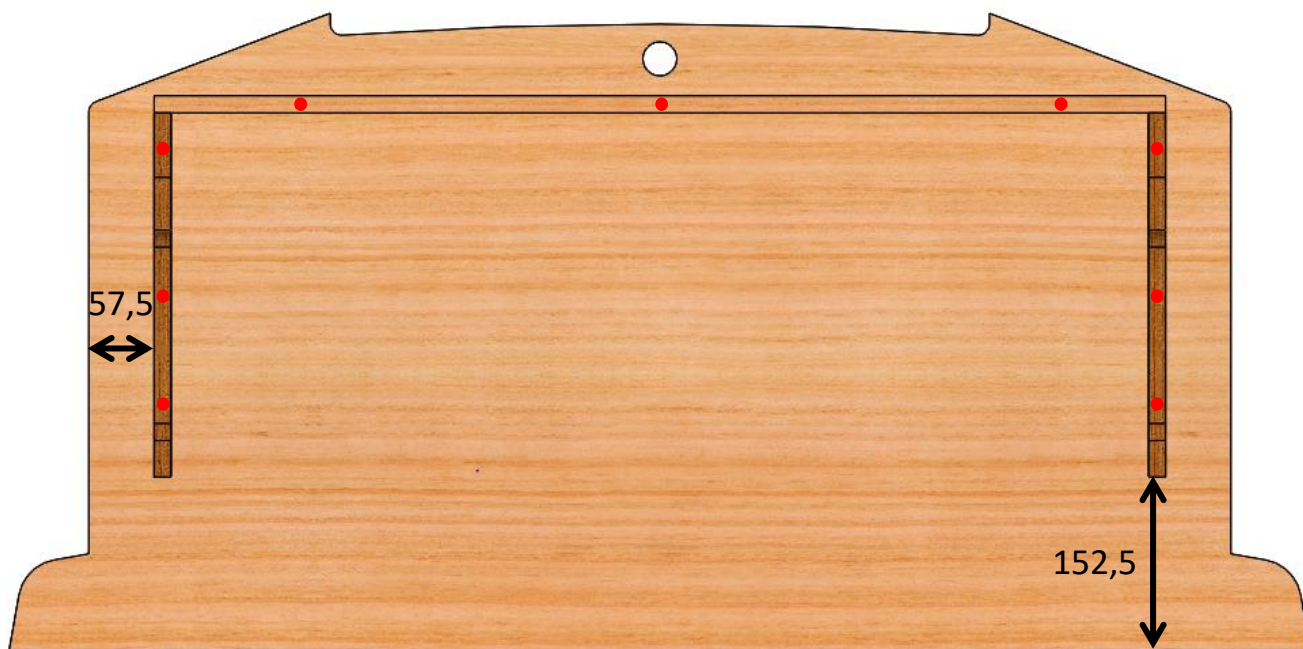

● Emplacement vis



Vis a bois
VIS BOIS 3,5 x 30
Qté : 11

KIT SOCIETE ARRET DE CHARGES

17) Monter le plancher arrière B0953

Fixer le plancher à l'aide de 2 charnière et 8 vis charnière

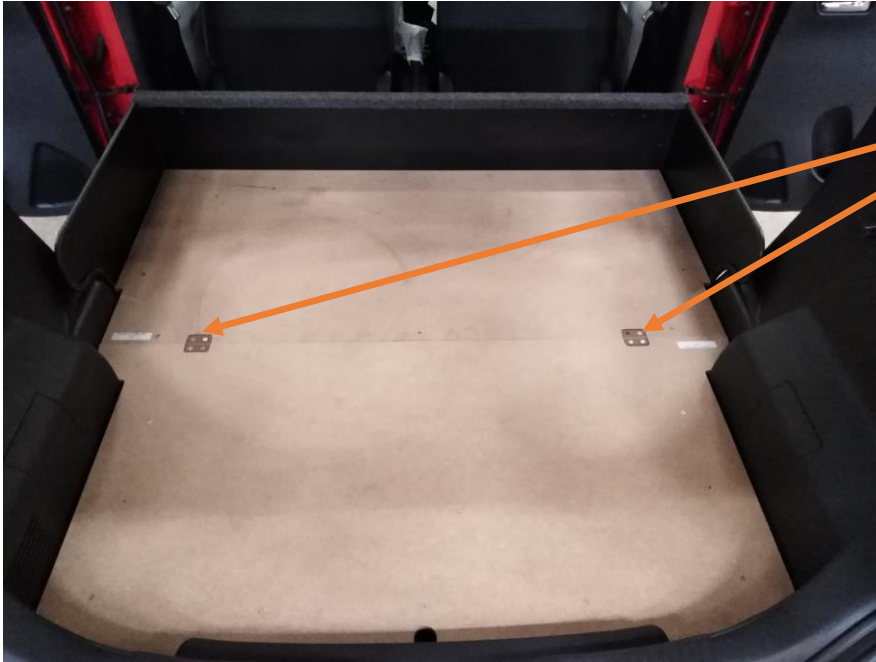

Charnière
charnière plancher
Qté : 2



Vis charnière
FOR 295
Qté : 8

18) Mettre la moquette et mise en place des anneaux d'arrimages



Moquette M0964



Anneau arrimage
ACIER GALVA
Qté : 2



Vis poêlier 6 x 16
PLOVP616 Z
Qté : 2

KIT SOCIETE ARRET DE CHARGES

19) Coller la plaque de transformation :

Depuis le 1^{er} Juillet 2015, date d'entrée en vigueur de l'arrêté du 7 Novembre 2014, il n'y a plus ni plaque de tare ni plaque de chargement à apposer sur un véhicule transformé en VASP

**LA PLAQUE AUTOCOLLANTE EST EXPEDIEE AVEC LE KIT.
(DANS LE SACHET DE VISSERIE)**

COLLER LA PLAQUE DE TRANSFORMATION A PROXIMITE DE LA PLAQUE CONSTRUCTEUR

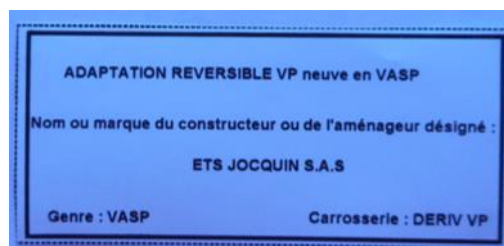

20) Nettoyer le véhicule



MARQUE DU VEHICULE :	
TYPE DU VEHICULE :	
N° de CLEF du VEHICULE :	

IFAB111
INDICE A

	OPERATION	Conforme C	Non conforme NC	OBSERVATIONS
1	RECEPTION DU VEHICULE VERIFIER N° SERIE	C	NC	
2	CONTRÔLE DU KIT	C	NC	
3	PRESENCE NOTICE MONTAGE	C	NC	
4	DEMONTAGE des EQUIPEMENTS SELON MODE OPERATEUR	C	NC	
5	PREPARATION DE L'HABITACLE Ex : vis pastilles joints	C	NC	
6	MONTAGE STRUCTURE METALLIQUE ARRET DE CHARGE	C	NC	
7	FIXATION DU PLANCHER SELON COUPLE DE SERRAGE	C	NC	
8	POSE DE LA MOQUETTE VERIFIER L'ETAT	C	NC	
9	INSTALLATION ELEMENTS FINITION Vérifier : caches, carres de moquette, anneau arrimage	C	NC	
10	POSE DE L'ETIQUETTE VASP	C	NC	
11	NETTOYAGE DU VEHICULE	C	NC	

NOM DU MONTEUR :	
DATE DE L'INTERVENTION :	
SIGNATURE DU MONTEUR :	

CACHET DU CARROSSIER / GARAGISTE :

KIT SOCIETE ARRET DE CHARGES

ATTENTION : Les cotes de chargement sont données
Sans les banquettes arrières

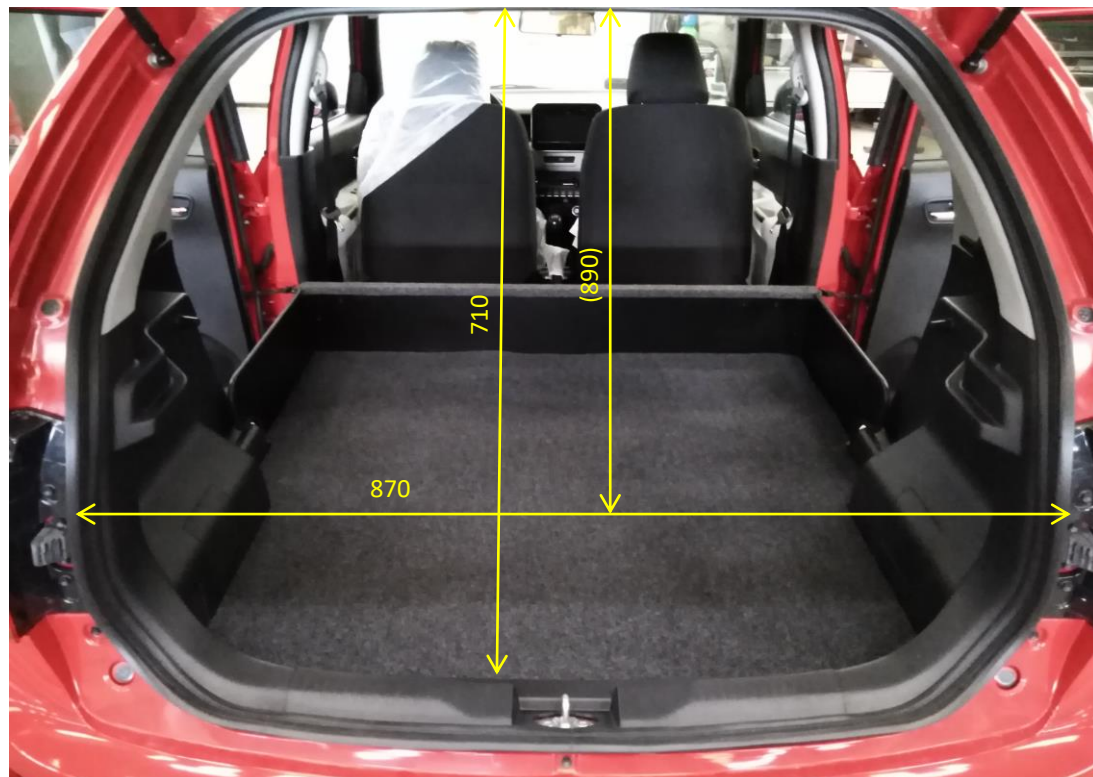
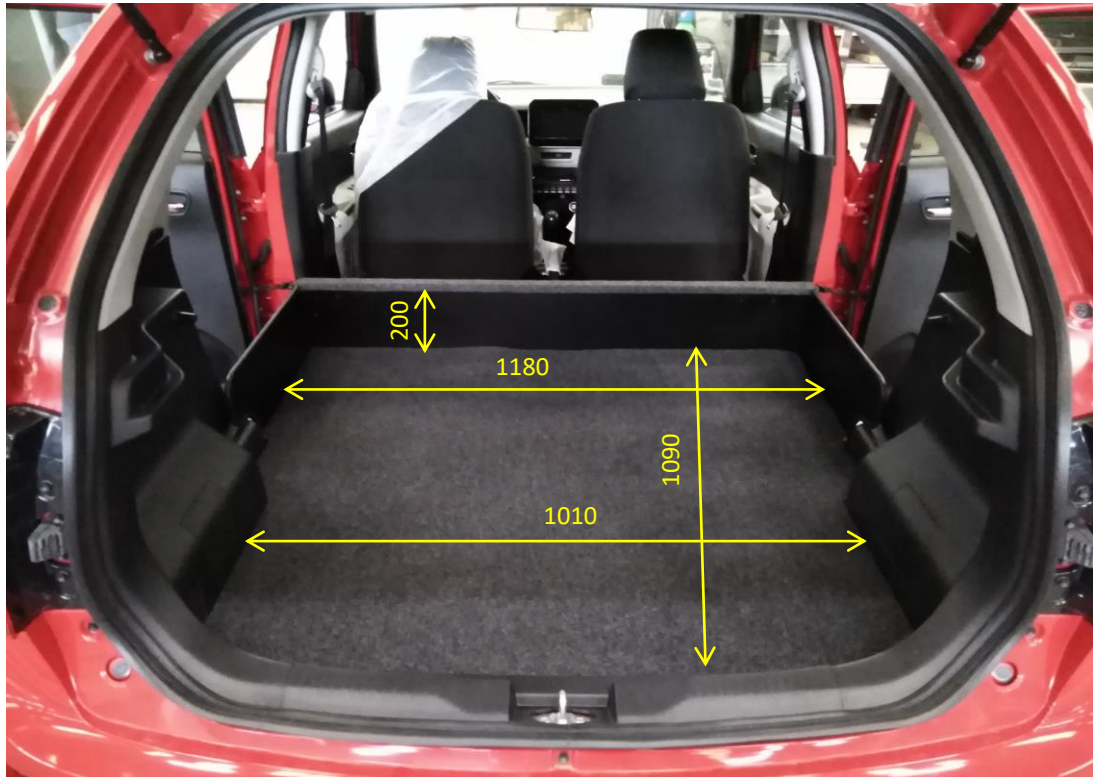

(890) hauteur intérieure plancher / plafond

Masse ensemble banquette : 38 Kg

Masse ensemble Kit société : 27 Kg