

REF DU DOCUMENT : N0583 HY15032017 IO

M.A.J Le : 16/11/2022
Indice de modif : Ind A
Nom dessinateur : JR



HYUNDAI IONIQ ELECTRIQUE 2017
KIT SOCIETE
NOTICE DE MONTAGE













Tout intervenant sur ce véhicule doit disposer de la formation et de l'habilitation spécifiques nécessaires (Norme UTE C18-550).

COMPOSITION DU COLIS

REF	DESIGNATION	QTE
TO0557	ENVELOPPE ARRET DE CHARGE	1
TO0582	CONSOLE FIXATION TRAVERSE	2
TO0559	TRAVERSE	1
TO0560	EQUERRE AVANT SUPPORT PLANCHER	1
TO0561	EQUERRE LATERALE SUPPORT PLANCHER	2
TO0581	PLATINE FIXATION ENVELOPPE	2
B0570	PLANCHER	1
M0576	MOQUETTE	1
N0583	NOTICE DE MONTAGE	1
TO580	TRAVERSE AVANT	1
V0575	SACHET VISSERIE (VOIR COMPOSITION TABLEAU CI-DESSOUS)	1

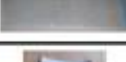
Composition du sachet de visserie :

REF ARTICLE	DESIGNATION	QTE	PHOTO
POM825	ANNEAU ARRIMAGE	2	
PLO616N	VIS POELIER 6 X 16 N	7	
PLOVP6X16	VIS POELIER 6 X 16 Z	6	
PLOVH6X16	VIS TETE HEXAGONALE M6	4	
FOR925	VIS FIXATION PLANCHER	8	
PLOCL6	ECROU M6 TENSILOCK	11	
PLOT6	RONDELLE DIAMETRE EXT 24	2	
PLOMU6	RONDELLE DIAMETRE EXT 14	2	
MOS229	COLLIER RILSAN	4	
400802	SACHET PLASTIQUE	4	
FOR791	CLIPS ECROU	2	

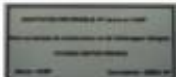
////	Plaque autocollante de transformation VASP	1	
------	--	---	---



REF DU DOCUMENT : N0583 HY15032017 IO

KIT SOCIETE ARRET DE CHARGE

EQUERRE AV SUPPORT
PLANCHER REF TO0560

ENVELOPPE ARRET DE CHARGE REF TO0557

EQUERRE LAT SUPPORT
PLANCHER REF TO0561
QTE 2

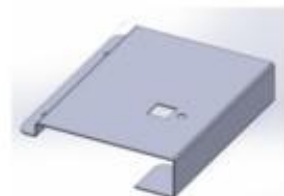
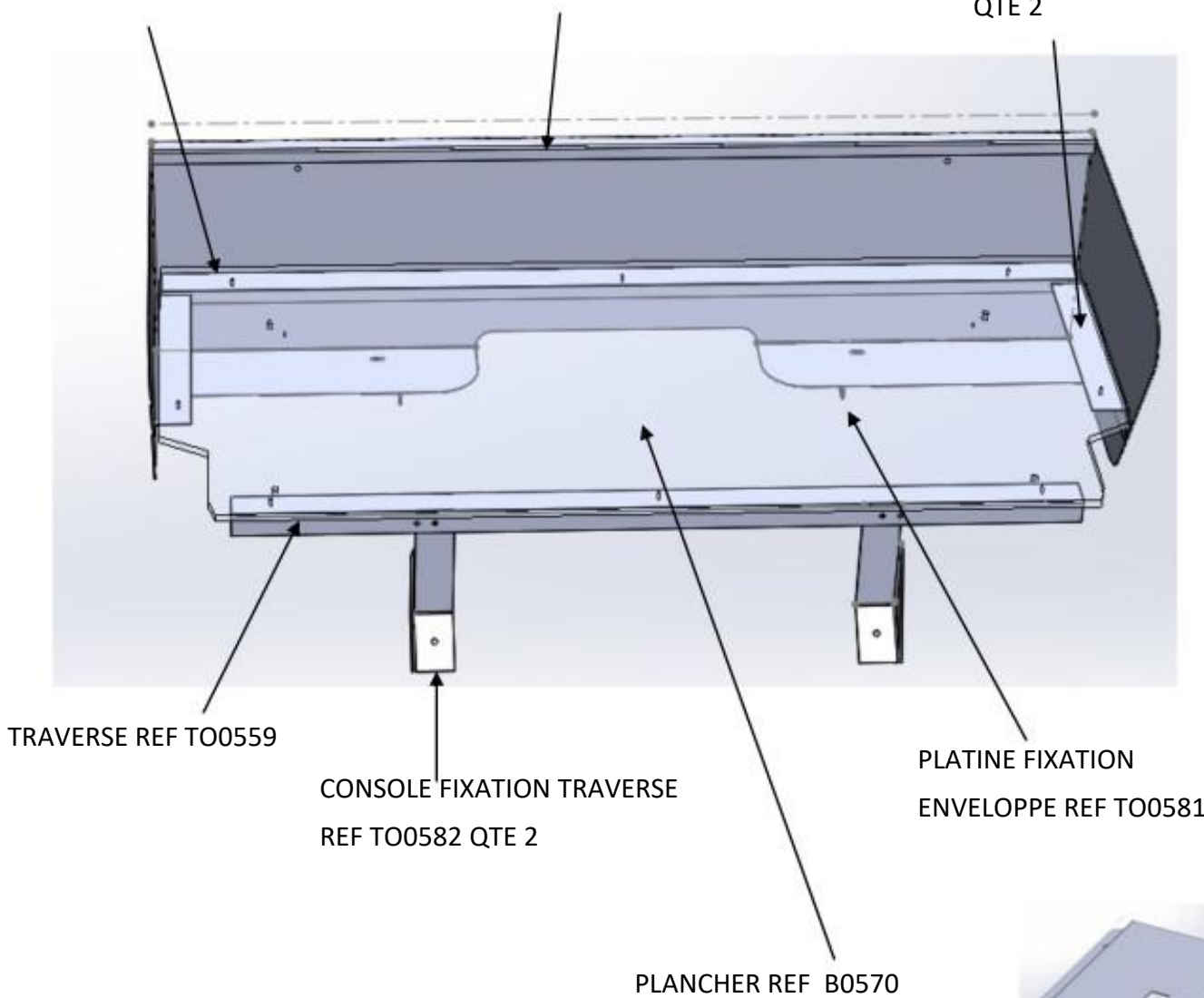

- 1) Réceptionner le véhicule et vérifier le N° de série .
Placer le véhicule sur une aire de travail propre et stable
- 2) Contrôler le kit .
- 3) Lire la notice de montage.

ATTENTION :

LA BATTERIE DU VEHICULE DOIT IMPERATIVEMENT ETRE DEBRANCHEE PENDANT LA DUREE DE L'INTERVENTION

- 4) Démontez les équipements dans l'ordre suivant :
 - a) Démontez la plage arrière



- b) Démontez les assises et les dossiers



c) Démontez les aménagements Du coffre .



d) Conditionner les ceintures

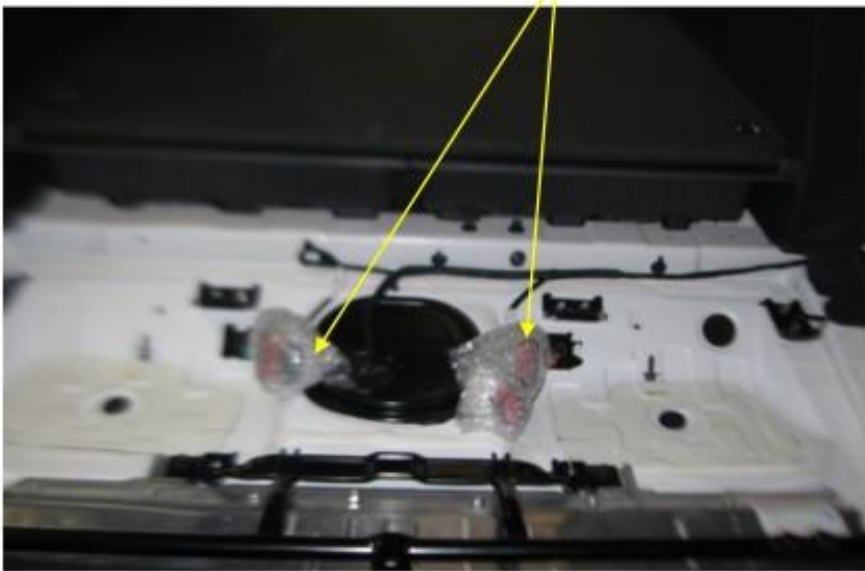

2 x REF 400802



2 x REF MOS229



ATTENTION POUR LE CONDITIONNEMENT DES CEINTURES IL EST IMPERATIF DE LAISSER 50 cm DE GARDE POUR EVITER LE BLOCAGE DEFINITIF DU SYSTEME D'ENROULEUR .

e) Démontez les garnitures latérales et conditionner les ceintures



1 x REF 400802



4 x REF MOS229



KIT SOCIETE ARRET DE CHARGE

5) Monter la structure dans l'ordre suivant:

a) Préparer les pièces REF TO0581 et mettre le clips écrou

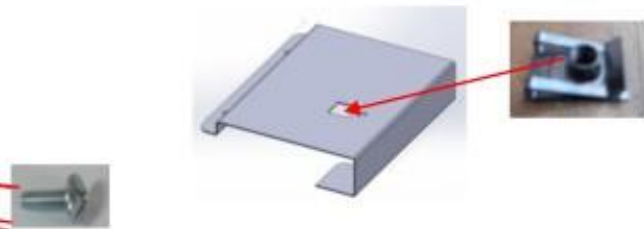

4 x REF PLOVP6X16

b) Positionner les pièces REF TO0582 avec les vis d'origine du véhicule et les serrer .

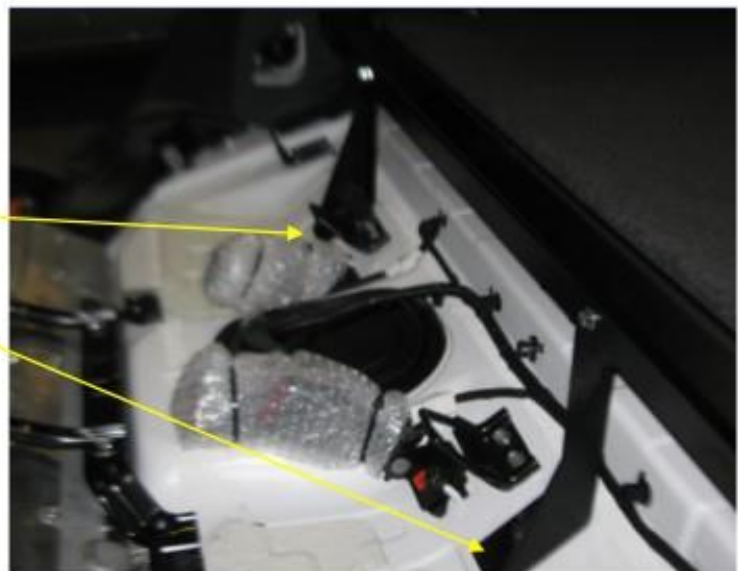
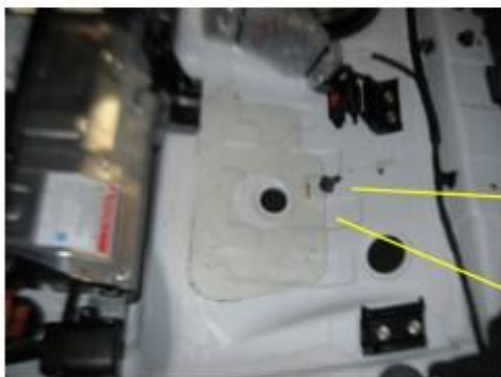

FIXATION VERSION
2017

FIXATION VERSION
2018

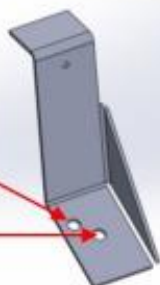

c) Positionner et fixer la pièce REF TO0559 .

2 x REF PLOMU6 + 2 x REF PLOVH6X16



d) Fixer les cornières sur l'enveloppe de arrêt de charge

7 VIS POELIER PLO616N + 7 ECROUS PLOTE6



1 cornière REF TO0560

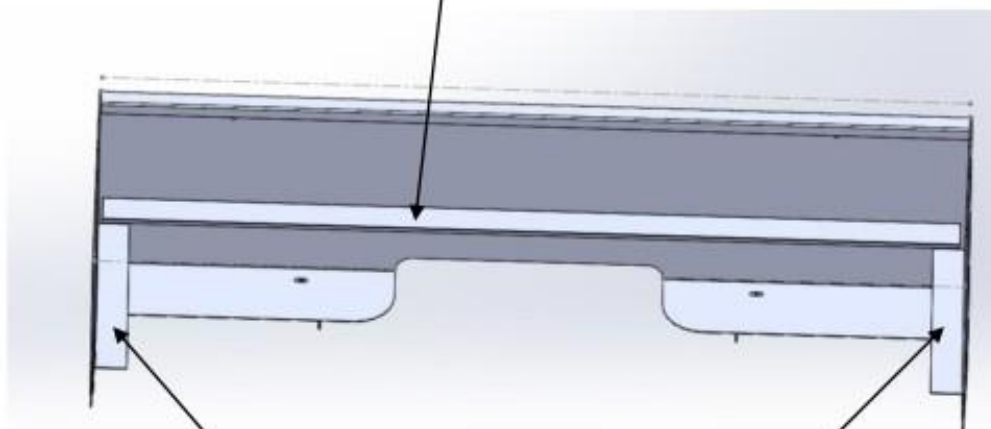

2 cornières REF TO0561



REF DU DOCUMENT : N0583 HY15032017 IO

f) Fixer l'enveloppe de arrêt de charge`

2 x PLOVH6X16 + 2 x PLOT6

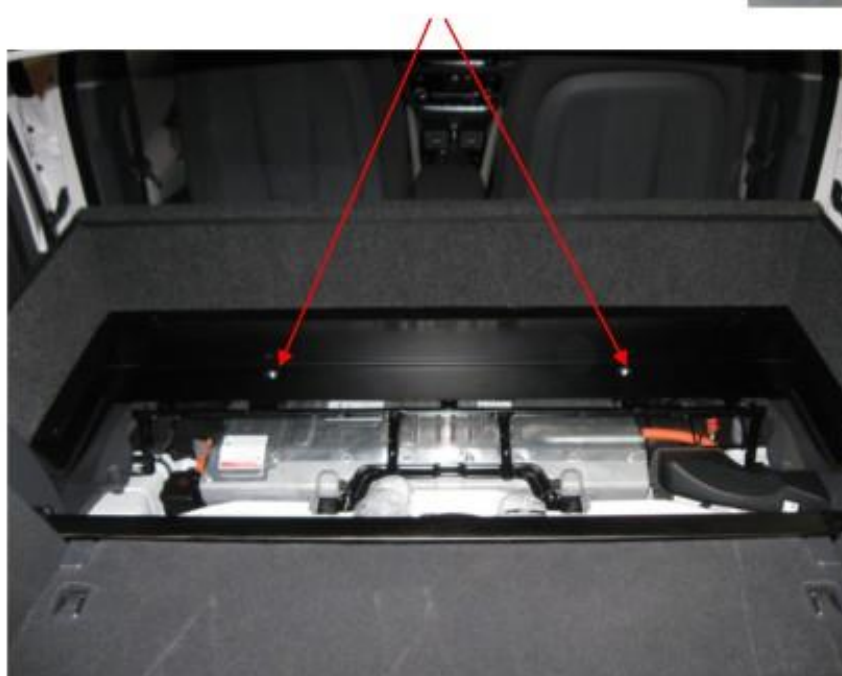



REF DU DOCUMENT : N0583 HY15032017 IO

g) Préparer la moquette selon la configuration du coffre arrière .

Sans boomer



Avec boomer



Partie de la moquette a découper





h) Positionner et fixer le plancher .

8 x REF FOR925



i) Placer correctement la moquette et fixer les anneaux d'arrimage



2 x REF PLOVP6X16 + 2 x REF POM825





5) Coller la plaque de transformation :

Depuis le 1^{er} Juillet 2015 , date d'entrée en vigueur de l'arrêté du 7 Novembre 2014 , il n'y a plus ni plaque de tare ni plaque de chargement a apposer sur un véhicule transformé en VASP.

**LA PLAQUE AUTOCOLLANTE EST EXPEDIEE AVEC LE KIT .
(DANS LE SACHET DE VISSERIE)**

COLLER LA PLAQUE DE TRANSFORMATION A PROXIMITE DE LA PLAQUE CONSTRUCTEUR.

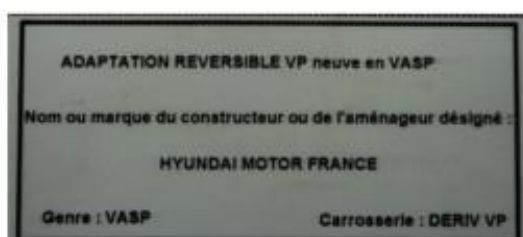

6) Nettoyer le véhicule.



MARQUE DU VEHICULE :	
TYPE DU VEHICULE :	
N° de CLEF du VEHICULE :	

IFAB111

INDICE A

	OPERATION	Conforme	Non conforme	OBSERVATIONS
		C	NC	
1	RECEPTION DU VEHICULE VERIFIER N° SERIE	C	NC	
2	CONTRÔLE DU KIT	C	NC	
3	PRESENCE NOTICE MONTAGE	C	NC	
4	DEMONTAGE des EQUIPEMENTS SELON MODE OPERATEUR	C	NC	
5	PREPARATION DE L'HABILITATION Ex : vis pastilles joints	C	NC	
6	MONTAGE STRUCTURE METALLIQUE ARRET DE CHARGE	C	NC	
7	FIXATION DU PLANCHER SELON COUPLE DE SERRAGE	C	NC	
8	POSE DE LA MOQUETTE VERIFIER L'ETAT	C	NC	
9	INSTALLATION ELEMENTS FINITION Vérifier : caches, carres de moquette, anneau arrimage	C	NC	
10	POSE DE L'ETIQUETTE VSP	C	NC	
11	NETTOYAGE DU VEHICULE	C	NC	

NOM DU MONTEUR :	
DATE DE L'INTERVENTION :	
SIGNATURE DU MONTEUR :	

CACHET DU CARROSSIER / GARAGISTE :

