

**REF DU DOCUMENT : N0623 SS15092016 TIXLV**

M.A.J Le : 15/11/2022  
Indice de modif : Ind A  
Nom dessinateur : JR



**SSANGYONG**













**TIVOLI XLV MODELE 2016**



**COMPOSITION DU COLIS**

REF	DESIGNATION	QTE
N0623	NOTICE DE MONTAGE	1
M0625/M0164	MOQUETTE PLANCHER ( version véhicule long ou court)	1
B0622	TRAPPE PLANCHER	1
B0621/B0141	PLANCHER ( version véhicule long ou court)	1G / 1D
TO0150	PLATINE FIXATION PLANCHER	1
AS0152	TRAVERSE SUPPORT STRUCTURE	1
S0618	STRUCTURE PRINCIPALE PARTIE FIXE	1
S0619	STRUCTURE PARTIE COULISSANTE	1
TO0151	FLASQUES ENVELOPPE	1G / 1D
TO0138	ENVELOPPE ARRET DE CHARGE	1
V0624	SACHET DE VISSERIE (VOIR CI-DESOUS)	1

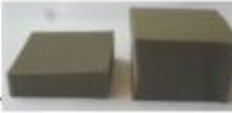
Composition du sachet de visserie :

REF	DESIGNATION	QTE	
DEC164	ANNEAU ARRIMAGE	4	
PLOTE6	ECROU TENSILOCK	6	
FOR925	VIS TECK 3.9x25	17	
PLOVH6x40	VIS TETE HEXAGONALE	2	
DEC7314	RIVET 4.8x14	12	
PLOVTF6x20	VIS TETE FRAISEE BTR	4	
PLOVP6x25	VIS POELIER ZINGUEE Lg25	4	
MOS11721	BOUCHON 25x25	6	
FOR285	COLLIER TYPE RILSAN	6	
PLOVH6X16	VIS TETE HEXAGONALE 6x16	2	
	CARRE FILM BULLES 300x300	2	
	BLOC MOUSSE 100x100 ep70	2	
	BLOC MOUSSE 100x100 ep40	2	
	1 PLAQUE AUTOCOLLANTE TRANSFORMATEUR VASP		



### KIT SOCIETE ARRET DE CHARGE

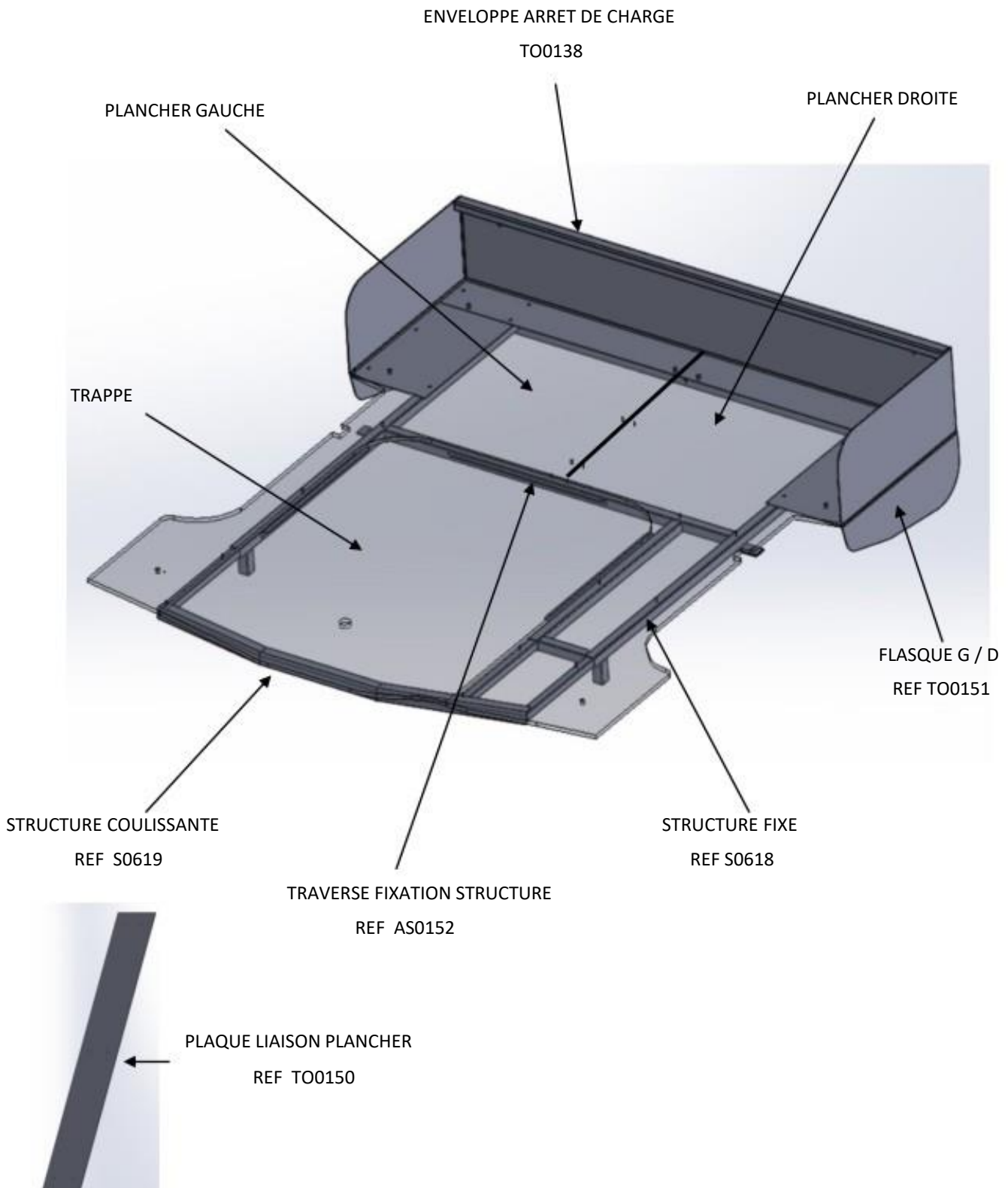

## KIT SOCIETE ARRET DE CHARGE

- 1) Réceptionner le véhicule et vérifier le N° de série .  
Placer le véhicule sur une aire de travail propre et stable
- 2) Contrôler le kit .
- 3) Lire la notice de montage.
- 4) Démontez les équipements dans l'ordre suivant :

Démontez la tablette arrière



Enlever le plancher du coffre .



Baisser les dossiers .



Dévisser les fixations et enlever l'ensemble assise/ dossier

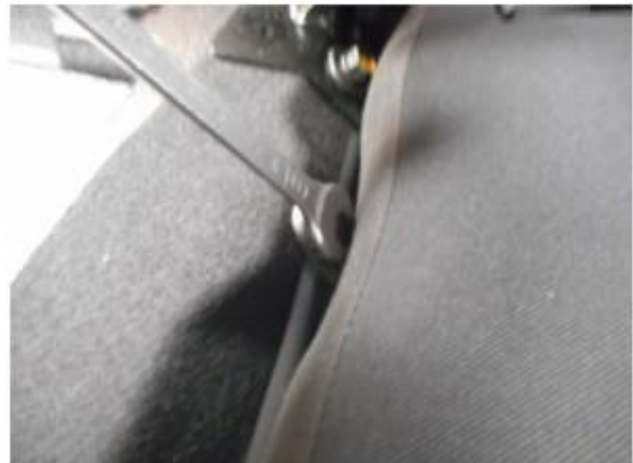

Démonter les attaches des ceintures

Replacer les éléments de fixation  
d'origine



ATTENTION : POUR LE CONDITIONNEMENT DES CEINTURES AR IL EST IMPERATIF DE LAISSER 1 M DE GARDE AU NIVEAU DE LA BOUCLE POUR EVITER LE BLOC GE DEFINITIF DU SYST ME D'ENROULEUR

Démonter les garnitures latérales et conditionner les ceintures de sécurité avec les morceaux de film bulles et les colliers « RILS N »



Démonter les fixations des dossiers

## 5) Remonter les garnitures :

Remonter les garnitures en plaçant les blocs de moussé

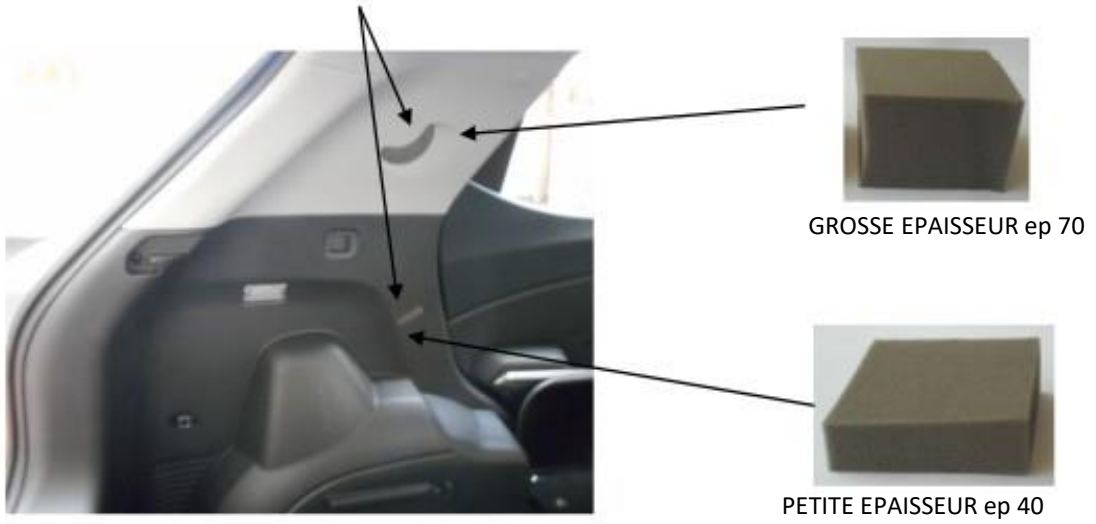

## 6) Monter la structure métallique arrêt de charge dans l'ordre suivant :

Assembler les 2 parties de la structure sans les bloquer .

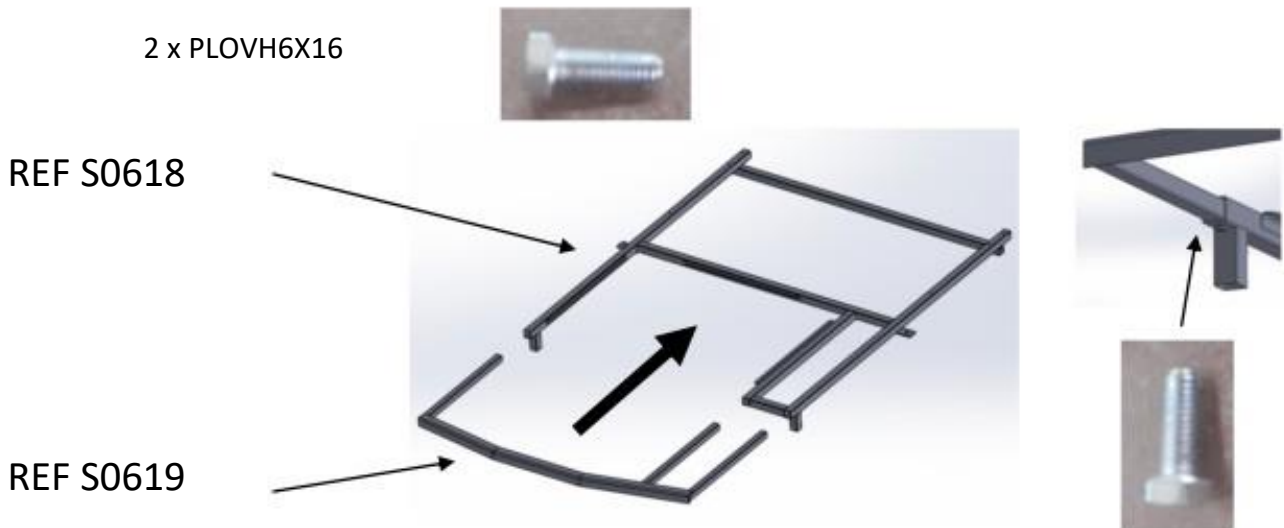

Monter les embouts .

4 x REF MOS11721

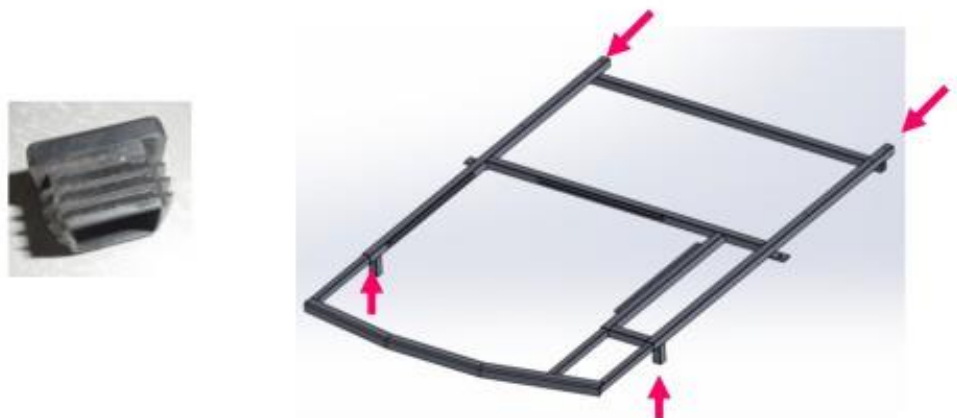

2 ) Fixer le socle avec les fixations d'origine du véhicule.



3 ) Fixer la structure principale avec les fixations d'origine du véhicule et les vis tête hexagonale Lg 40.

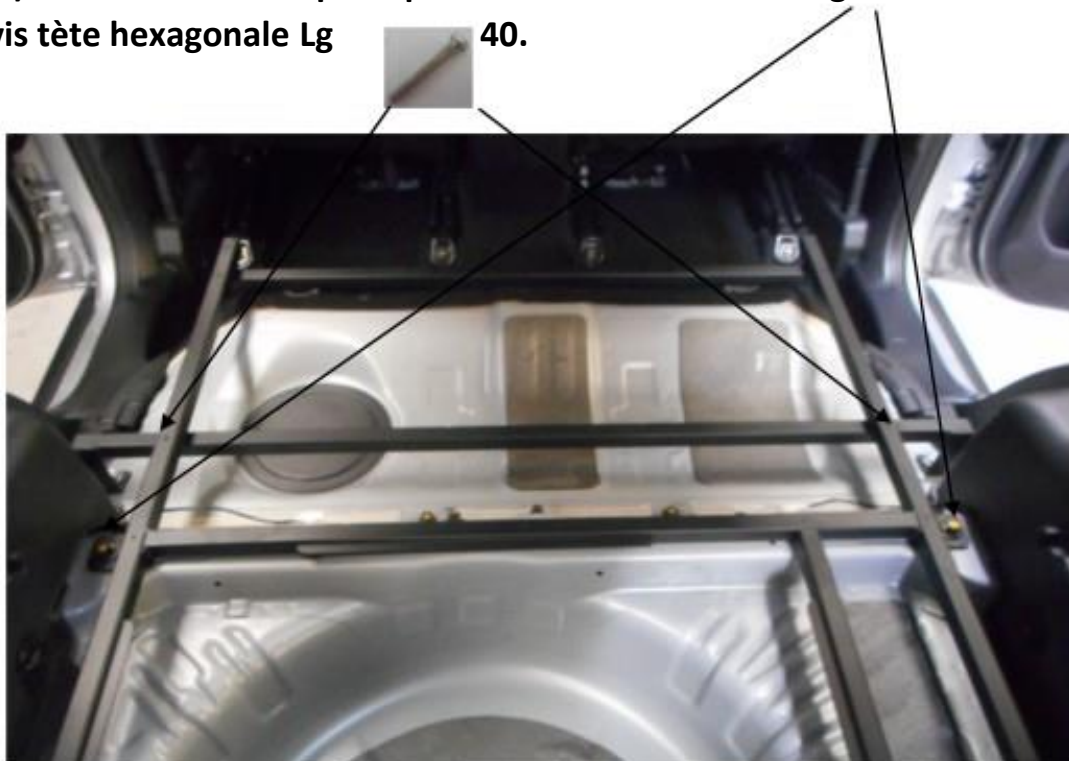

**4) Placer l'enveloppe « arrêt de charge<sup>d</sup> » et les flasques et les fixer avec les rivets.**

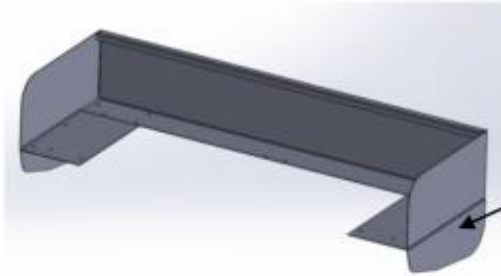

2 Flasque REF T00151

6 RIVETS REF DEC7314 POUR L'ASSEMBLAGE DES FLASQUES



6 RIVETS REF DEC7314 POUR L'ASSEMBLAGE DE L'ENVELOPPE SUR LA STRUCTURE







5 ) Coller la plaque de transformation :

Depuis l'entrée en vigueur de l'arrête du 7 Novembre 2014 , il n'y a plus ni plaque de tare ni plaque de chargement a apposer sur un véhicule transformé en VASP

**LA PLAQUE AUTOCOLLANTE EST EXPEDIEE AVEC LE KIT .**

**( DANS LE SACHET DE VISSERIE )**

COLLER LA PLAQUE DE TRANSFORMATION A PROXIMITE DE LA PLAQUE CONSTRUCTEUR.

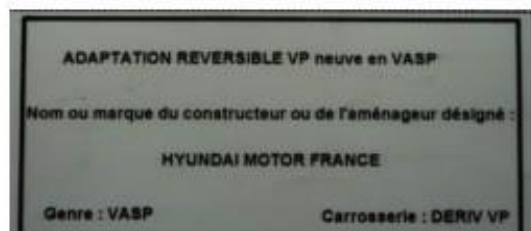
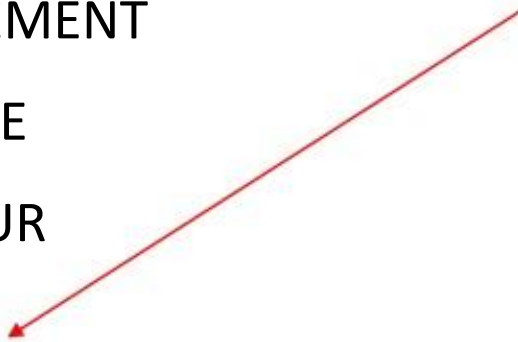

PHOTO EMPLACEMENT  
DE LA PLAQUE  
CONSTRUCTEUR



6 ) Nettoyer le véhicule.



## TIVOLI VERSION 2015

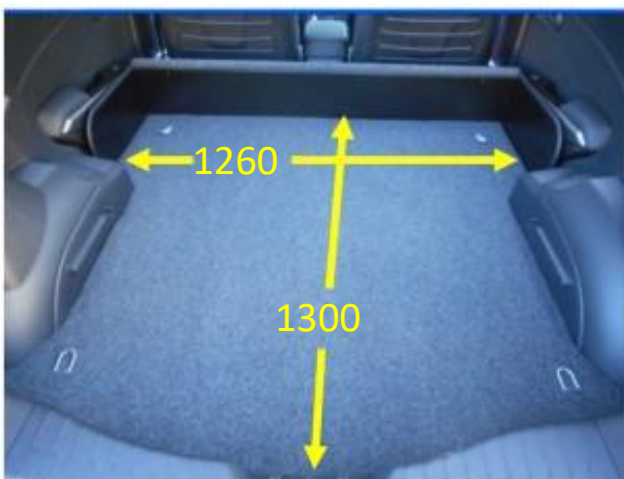



# TIVOLI XLV MODELE 2016

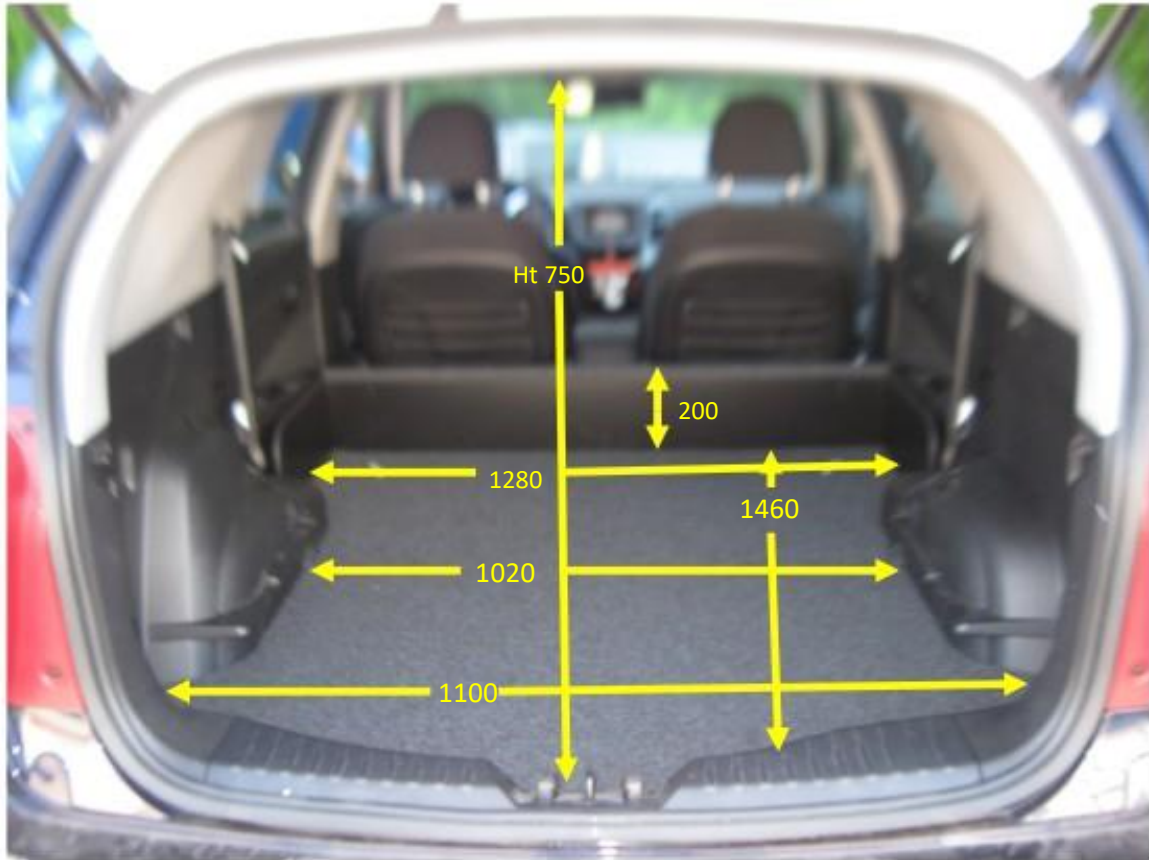



MARQUE DU VEHICULE :	
TYPE DU VEHICULE :	
N° de CLEF du VEHICULE :	

IFAB111

INDICE A

	OPERATION	Conforme	Non conforme	OBSERVATIONS
		C	NC	
1	RECEPTION DU VEHICULE VERIFIER N° SERIE	C	NC	
2	CONTRÔLE DU KIT	C	NC	
3	PRESENCE NOTICE MONTAGE	C	NC	
4	DEMONTAGE des EQUIPEMENTS SELON MODE OPERATEUR	C	NC	
5	PREPARATION DE L'HERMINETAGE Ex : vis pastilles joints	C	NC	
6	MONTAGE STRUCTURE METALLIQUE ARRET DE CHARGE	C	NC	
7	FIXATION DU PLANCHER SELON COUPLE DE SERRAGE	C	NC	
8	POSE DE LA MOQUETTE VERIFIER L'ETAT	C	NC	
9	INSTALLATION ELEMENTS FINITION Vérifier : caches, carres de moquette, anneau arrimage	C	NC	
10	POSE DE L'ETIQUETTE V SP	C	NC	
11	NETTOYAGE DU VEHICULE	C	NC	

NOM DU MONTEUR :	
DATE DE L'INTERVENTION :	
SIGNATURE DU MONTEUR :	

CACHET DU CARROSSIER / GARAGISTE :